

Projector

6542W/6545X/6442W/6445X/6540U

User's Manual

- Apple and Mac are trademarks of Apple Inc. registered in the U.S. and other countries.
- Microsoft and Windows are either a registered trademark or trademark of Microsoft Corporation in the United States and/or other countries.
- MicroSaver is a registered trademark of Kensington Computer Products Group, a division of ACCO Brands in the U.S. and other countries.
- The terms HDMI and HDMI High-Definition Multimedia Interface, and the HDMI Logo are trademarks or registered trademarks of HDMI Licensing Administrator, Inc. in the United States and other countries.



- Blu-ray is a trademark of Blu-ray Disc Association.
- CRESTRON and ROOMVIEW are registered trademarks of Crestron Electronics, Inc. in the United States and other countries.
- Other product names and logos mentioned in this user's manual may be the trademarks or registered trademarks of their respective holders.
- GPL/LGPL Software Licenses

The product includes software licensed under GNU General Public License (GPL), GNU Lesser General Public License (LGPL), and others.

For more information on each software, see "readme.pdf" in the "about GPL&LGPL" folder on the supplied CD-ROM.

NOTES

- (1) The contents of this user's manual may not be reprinted in part or whole without permission.
- (2) The contents of this user's manual are subject to change without notice.
- (3) Great care has been taken in the preparation of this user's manual; however, should you notice any questionable points, errors or omissions, please contact us.

Safety Cautions

Precautions

Please read this manual carefully before using your Dukane projector and keep the manual handy for future reference.

CAUTION



To turn off main power, be sure to remove the plug from power outlet. The power outlet socket should be installed as near to the equipment as possible, and should be easily accessible.

CAUTION



TO PREVENT SHOCK, DO NOT OPEN THE CABINET. THERE ARE HIGH-VOLTAGE COMPONENTS INSIDE. REFER SERVICING TO QUALIFIED SERVICE PERSONNEL.



This symbol warns the user that uninsulated voltage within the unit may be sufficient to cause electrical shock. Therefore, it is dangerous to make any kind of contact with any part inside of the unit.



This symbol alerts the user that important information concerning the operation and maintenance of this unit has been provided. The information should be read carefully to avoid problems.

WARNING: TO PREVENT FIRE OR SHOCK, DO NOT EXPOSE THIS UNIT TO RAIN OR MOISTURE. DO NOT USE THIS UNIT'S PLUG WITH AN EXTENSION CORD OR IN AN OUTLET UNLESS ALL THE PRONGS CAN BE FULLY INSERTED.

Machine Noise Information Regulation - 3. GPSGV,

The highest sound pressure level is less than 70 dB (A) in accordance with EN ISO 7779.

CAUTION



Avoid displaying stationary images for a prolonged period of time. Doing so can result in these images being temporarily sustained on the surface of the LCD panel. If this should happen, continue to use your projector. The static background from previous images will disappear.

Disposing of your used product



In the European Union

EU-wide legislation as implemented in each Member State requires that used electrical and electronic products carrying the mark (left) must be disposed of separately from normal household waste. This includes projectors and their electrical accessories. When you dispose of such products, please follow the guidance of your local authority and/or ask the shop where you purchased the product.

After collecting the used products, they are reused and recycled in a proper way. This effort will help us reduce the wastes as well as the negative impact to the human health and the environment at the minimum level.

The mark on the electrical and electronic products only applies to the current European Union Member States.

Outside the European Union

If you wish to dispose of used electrical and electronic products outside the European union, please contact your local authority and ask for the correct method of disposal.



For EU: The crossed-out wheeled bin implies that used batteries should not be put to the general household waste! There is a separate collection system for used batteries, to allow proper treatment and recycling in accordance with legislation.

According to EU directive 2006/66/EC, the battery can't be disposed improperly. The battery shall be separated to collect by local service.

FCC Information (for USA only)

WARNING

The Federal Communications Commission does not allow any modifications or changes to the unit EXCEPT those specified by Dukane in this manual. Failure to comply with this government regulation could void your right to operate this equipment. This equipment has been tested and found to comply with the limits for a Class B digital device, pursuant to Part 15 of the FCC Rules. These limits are designed to provide reasonable protection against harmful interference in a residential installation. This equipment generates, uses, and can radiate radio frequency energy and, if not installed and used in accordance with the instructions, may cause harmful interference to radio communications. However, there is no guarantee that interference will not occur in a particular installation.

If this equipment does cause harmful interference to radio or television reception, which can be determined by turning the equipment off and on, the user is encouraged to try to correct the interference by one or more of the following measures:

- Reorient or relocate the receiving antenna.
- Increase the separation between the equipment and receiver.
- Connect the equipment into an outlet on a circuit different from that to which the receiver is connected.
- Consult the dealer or an experienced radio / TV technician for help.

Supplier's declaration of conformity (for USA only)

This device complies with Part 15 of the FCC Rules. Operation is subject to the following two conditions.

(1) This device may not cause harmful interference, and (2) this device must accept any interference received, including interference that may cause undesired operation.

For UK only: In UK, a BS approved power cord with moulded plug has a Black (five Amps) fuse installed for use with this equipment. If a power cord is not supplied with this equipment please contact your supplier.

Important Safeguards

These safety instructions are to ensure the long life of your projector and to prevent fire and shock. Please read them carefully and heed all warnings.



Installation

- Do not place the projector in the following conditions:
 - on an unstable cart, stand, or table.
 - near water, baths, or damp rooms.
 - in direct sunlight, near heaters, or heat radiating appliances.
 - in a dusty, smoky or steamy environment.
 - on a sheet of paper or cloth, rugs or carpets.
- If you wish to have the projector installed on the ceiling:
 - Do not attempt to install the projector yourself.
 - The projector must be installed by qualified technicians in order to ensure proper operation and reduce the risk of bodily injury.
 - In addition, the ceiling must be strong enough to support the projector and the installation must be in accordance with any local building codes.

Important Information

- Please consult your dealer for more information.
- Do not install and store the projector in the below circumstances. Failure to do so may cause of malfunction.
 - In powerful magnetic fields
 - In corrosive gas environment
 - Outdoors
- If intense light like laser beams enters from the lens, it could lead to malfunction.

CAUTION



This equipment is designed to be used in the condition of the power cord connected to earth. If the power cord is not connected to the earth, it may cause electric shock. Please make sure the power cord is earthed properly.

Cable information

CAUTION



Use shielded cables or cables attached ferrite cores so as not to interfere with radio and television reception. For details, please refer to "Making Connections" in this user's manual.

WARNING

- Do not cover the lens with the lens cap or equivalent while the projector is on. Doing so can lead to melting of the cap due to the heat emitted from the light output.
- Do not place any objects, which are easily affected by heat, in front of the projection window. Doing so could lead to the object melting from the heat that is emitted from the light output.

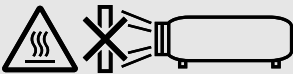

- Do not use a spray containing flammable gas to get rid of accumulated dust and dirt on the filter and the projection window. It may cause of fire.

Place the projector in a horizontal position

The tilt angle of the projector should not exceed 10 degrees, nor should the projector be installed in any way other than the desktop and ceiling mount, otherwise lamp life could decrease dramatically.

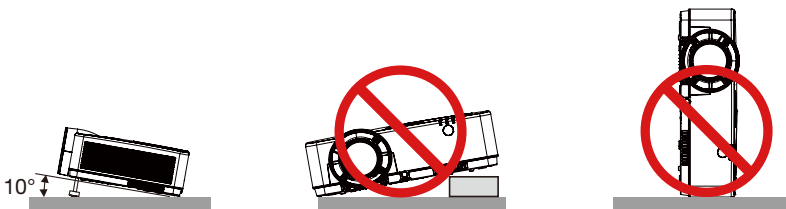

⚠ Fire and Shock Precautions ⚠

- Ensure that there is sufficient ventilation and that vents are unobstructed to prevent the build-up of heat inside your projector. Allow at least 4 inches (10 cm) of space between your projector and a wall.
- Do not try to touch the exhaust vent as it can become heated while the projector is turned on and immediately after the projector is turned off. Parts of the projector may become temporarily heated if the projector is turned off with the POWER button or if the AC power supply is disconnected during normal projector operation. Use caution when picking up the projector.



HOT

Important Information

- Prevent foreign objects such as paper clips and bits of paper from falling into your projector. Do not attempt to retrieve any objects that might fall into your projector. Do not insert any metal objects such as a wire or screwdriver into your projector. If something should fall into your projector, disconnect it immediately and have the object removed by a qualified service personnel.
- Do not place any objects on top of the projector.
- Do not touch the power plug during a thunderstorm. Doing so can cause electrical shock or fire.
- The projector is designed to operate on a power supply of 100-240V AC 50/60 Hz. Ensure that your power supply fits this requirement before attempting to use your projector.
- Do not look the lens while the projector is on. Serious damage to your eyes could result. The following logo, that is indicated near the lens-mounting-section on the projector cabinet, describes this projector is categorized in the risk group 2 of IEC 62471-5: 2015. As with any bright source, do not stare into the beam, RG2 IEC 62471-5: 2015.

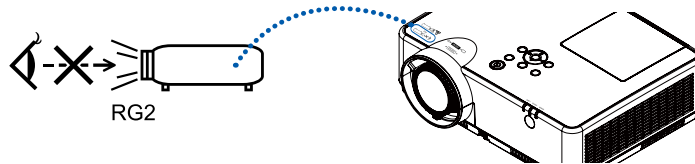

- Keep any items such as magnifying glass out of the light path of the projector. The light being projected from the lens is extensive, therefore any kind of abnormal objects that can redirect light coming out of the lens, can cause unpredictable outcome such as fire or injury to the eyes.
- Do not place any objects, which are easily affected by heat, in front of a projector exhaust vent. Doing so could lead to the object melting or getting your hands burned from the heat that is emitted from the exhaust.
- Do not splash water over the projector. Doing so can cause electrical shock or fire. If the projector gets wet, turn off the projector, unplug the power cord and have the projector serviced by a qualified service personnel.
- Handle the power cord carefully. A damaged or frayed power cord can cause electric shock or fire.
 - Do not use any power cord other than the one supplied with the projector.
 - Do not bend or tug the power cord excessively.
 - Do not place the power cord under the projector, or any heavy object.
 - Do not cover the power cord with other soft materials such as rugs.
 - Do not heat the power cord.
 - Do not handle the power plug with wet hands.
- Turn off the projector, unplug the power cord and have the projector serviced by a qualified service personnel under the following conditions:
 - When the power cord or plug is damaged or frayed.
 - If liquid has been spilled into the projector, or if it has been exposed to rain or water.
 - If the projector does not operate normally when you follow the instructions described in this user's manual.
 - If the projector has been dropped or the cabinet has been damaged.
 - If the projector exhibits a distinct change in performance, indicating a need for service.
- Disconnect the power cord and any other cables before carrying the projector.
- Turn off the projector and unplug the power cord before cleaning the cabinet or replacing the lamp.
- Turn off the projector and unplug the power cord if the projector is not to be used for an extended period of time.
- When using a LAN cable:
 - For safety, do not connect to the terminal for peripheral device wiring that might have excessive voltage.

CAUTION

- Do not use the adjustable tilt foot for purposes other than originally intended. Misuses such as gripping the tilt-foot or hanging on the wall can cause damage to the projector.
- Do not turn off the AC power for 60 seconds after the lamp is turned on and while the POWER indicator is blinking blue. Doing so could cause premature lamp failure.

Remote Control Precautions

- Handle the remote control carefully.
- If the remote control gets wet, wipe it dry immediately.
- Avoid excessive heat and humidity.
- Do not short, heat, or take apart batteries.
- Do not throw batteries into fire.
- If you will not be using the remote control for a long time, remove the batteries.
- Ensure that you have the batteries' polarity (+/-) aligned correctly.
- Do not use new and old batteries together, or use different types of batteries together.
- Dispose of used batteries according to your local regulations.

Note for Canadian Environmental Protection Act, 1999

The lamp(s) in this product contains mercury. Please dispose according to your local authority law.

Note for US Residents

The lamp in this product contains mercury. Please dispose according to Local, State or Federal Laws.

Lamp Replacement

- Use the specified lamp for safety and performance.
- To replace the lamp, follow all instructions provided on page 86.

A Lamp Characteristic

The projector has a discharge lamp for special purposes as a light source.

A lamp has a characteristic that its brightness gradually decreases with age. Also repeatedly turning the lamp on and off will increase the possibility of its lower brightness.

The actual lamp life may vary depending upon the individual lamp, the environmental conditions and usage.

CAUTION:

- DO NOT TOUCH THE LAMP immediately after it has been used. It will be extremely hot. Turn the projector off and then disconnect the power cord. Allow at least one hour for the lamp to cool before handling.
- When removing the lamp from a ceiling-mounted projector, make sure that no one is under the projector. Glass fragments could fall if the lamp has been burned out.

About High Altitude mode

- Set [High altitude] to [ON] in the Setting menu when [using the projector at altitudes approximately 1700 meters or higher].
Using the projector at an altitude of about 1700 meters or more without setting [High altitude] to [ON] can cause the projector to overheat and shut down the protector.
- Using the projector at altitudes less than approximately 1700 meters and setting it to [ON] can cause the light module to overcool, causing the image to flicker. Switch [High altitude] to [OFF].
- Using the projector at altitudes approximately 1700 meters or higher can shorten the life of optical components such as the light module.

About Copyright of original projected pictures:

Please note that using this projector for the purpose of commercial gain or the attraction of public attention in a venue such as a coffee shop or hotel and employing compression or expansion of the screen image with the following functions may raise concern about the infringement of copyrights which are protected by copyright law.

[ASPECT], [KEYSTONE], Magnifying feature and other similar features.

Turkish WEEE information relevant for Turkish market

AEEE Yönetmeliğine Uygundur.

This device is not intended for use in the direct field of view at visual display workplaces. To avoid incommoding reflections at visual display workplaces this device must not be placed in the direct field of view.

Power management function

The projector has power management functions. To reduce power consumption, the power management functions (1 and 2) are factory preset as shown below. To control the projector from an external device via a LAN or serial cable connection, use the on-screen menu to change the settings for 1 and 2.

1. STANDBY MODE (Factory preset: NORMAL)

To control the projector from an external device, select [NETWORK STANDBY] or [SLEEP] for [STANDBY MODE].

NOTE:

- When [NORMAL] is selected for [STANDBY MODE], the following terminals and functions will not work: COMPUTER OUT terminal, AUDIO OUT terminal, LAN functions. Please refer to page 37 about details.

2. Power management (Factory preset: Ready)

To control the projector from an external device, select [OFF] for [Power management].

NOTE:

- When [5 Min] is selected for [Timer], you can enable the projector to automatically turn off in 5 Min if there is no signal received by any input or if no operation is performed.

Important Information	I
1. Introduction	1
1 What's in the Box?	1
2 Introduction to the Projector	2
About this user's manual	2
3 Part Names of the Projector.....	3
Front/Top	3
Rear	4
Top Features.....	5
Terminal Panel Features	6
4 Part Names of the Remote Control	7
Battery Installation	8
Remote Control Precautions	8
Operating Range for Wireless Remote Control	8
2. Projecting an Image (Basic Operation)	9
1 Flow of Projecting an Image.....	9
2 Connecting Your Computer/Connecting the Power Cord	10
3 Turning on the Projector.....	11
4 Selecting a Source	12
Selecting the computer or video source.....	12
5 Adjusting the Picture Size and Position	13
Adjust the Tilt Foot.....	14
Zoom.....	15
Focus	15
6 Correcting Keystone Distortion [KEYSTONE]	16
7 Optimizing Computer Signal Automatically	17
Adjusting the Image Using Auto Adjust.....	17
8 Turning Up or Down Volume	17
9 Turning off the Projector	18
10 When Moving the Projector.....	19
3. Convenient Features	20
1 Turning off the Image and Sound.....	20
2 Freezing a Picture.....	20
3 Magnifying a Picture.....	20
4. Using the VIEWER	22
Memory viewer function.....	22
5. Using On-Screen Menu	24
1 Menu item overview	24
2 List of Menu Items.....	25
3 Menu Descriptions & Functions [INPUT].....	28
Computer	28

HDMI1 and HDMI2	28
Video.....	28
USB-A.....	28
LAN	28
4 Menu Descriptions & Functions [Display menu].....	29
[Auto PC adj.].....	29
[Fine sync].....	29
[H position].....	29
[V position]	30
[H. size]	30
[Aspect].....	30
[Orientation]	31
[Menu position]	31
[Background display]	32
[Signal format].....	32
5 Menu Descriptions & Functions [Color adjust].....	34
[Image mode].....	34
[Color adjust].....	34
6 Menu Descriptions & Functions [Setting]	36
[On start]	36
[Standby mode]	37
[High altitude].....	37
[ECO mode]	38
[Cooling fast].....	38
[Closed caption].....	39
[Key lock]	39
[Iris]	40
[Baud rate]	40
[Sound].....	41
[HDMI setup].....	41
7 Menu Descriptions & Functions [Expand]	43
[Language]	43
[Auto setup].....	44
[Keystone].....	44
[Security].....	48
[Power management].....	49
[Filter]	50
[Network setup].....	51
[Control ID].....	52
[Factory default].....	53
[Lamp counter reset].....	53
8 Menu Descriptions & Functions [USB-A]	54
[Set slide]	54
[Slide transition effect]	54
[Sort order].....	55
[Rotate]	55
[Best fit].....	55
[Repeat].....	55
[Apply].....	55
9 Menu Descriptions & Functions [Info.]	56

6. Network control	57
1 Network control operation.....	57
2 Enter through a Web browser	58
Connecting Your Computer.....	58
3 [System status] page.....	59
4 [General setup] page.....	59
5 [Picture setup] page	59
6 [Image setup] page.....	60
7 [Network setup] page.....	61
7. Installation and Connections	62
1 Setting Up the Screen and the Projector	62
Throw Distance and Screen Size.....	68
2 Making Connections	71
Connecting Your Computer.....	71
Connecting an External Monitor.....	73
Connecting Your DVD Player or Other AV Equipment	74
Connecting Component Input	75
Connecting HDMI Input.....	76
Connecting to a Wired LAN.....	77
Connecting to a Wireless LAN (Optional: NP05LM series).....	77
8. Connecting to a Network	80
1 Things you can do by connecting the projector to a network.....	80
2 Connecting to MultiPresenter	81
9. Maintenance	82
1 Cleaning the Filter	82
2 Cleaning the Lens.....	84
3 Cleaning the Cabinet.....	84
4 Replacing the Lamp and the Filter	85
10. Appendix.....	90
1 Troubleshooting	90
Feature of each indicator.....	90
Indicator Message (Status message)	90
Indicator Message (Error message).....	91
2 Specifications.....	92
3 Cabinet Dimensions	94
4 Pin Assignments of D-Sub COMPUTER Input Terminal.....	96
5 Compatible Input Signal List.....	97
6 PC Control Codes and Cable Connection	99
7 Troubleshooting Check List	101
8 REGISTER YOUR PROJECTOR! (for residents in the United States, Canada, and Mexico).....	103

1. Introduction

1 What's in the Box?

Make sure your box contains everything listed. If any pieces are missing, contact your dealer. Please save the original box and packing materials if you ever need to ship your projector.

Projector

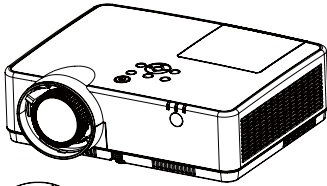

*Lens cap (440092200)
Lens cap strap × 1 (410034900)*

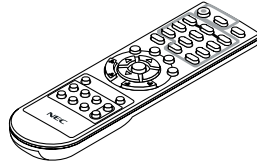

*Remote control
(393004710)*

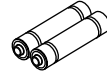

*Batteries (AAA × 2)
(391003200)*

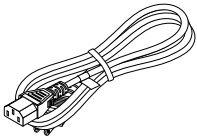

*Power cord
(US: 310004900)
(EU: 310003100)*

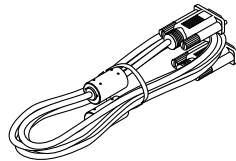

*Computer cable (VGA)
(310002200)*

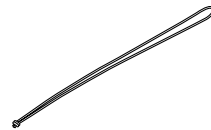

*Strap × 1
(410035000)*

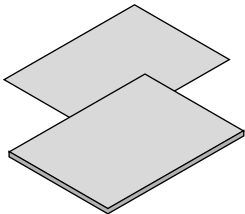

- *Important Information (510048600)*
- *Quick Setup Guide(UG) (510048900)*
- *Quick Setup Guide(G2) (510048700)*

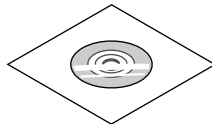

*Dukane Projector CD-ROM
User's manual (PDF)
(510048500)*

Unless otherwise described in the user's manual, the drawings for the projector cabinet show examples of the ME403U.

2 Introduction to the Projector

This section introduces you to your new projector and describes the features and controls.

- **Simple Computer System Setting**
The projector has the Multi-scan system to conform to many computer output signals quickly. Up to WUXGA resolution can be accepted.
- **Useful Functions for Presentations**
The digital zoom function allows you to focus on the crucial information during a presentation.
- **Brightness adjustment**
Brightness of the projection lamp can be selected.
- **Multilanguage Menu Display**
The screen menu of the projector is available in 27 languages: English, German, French, Italian, Spanish, Polish, Swedish, Dutch, Portuguese, Japanese, Simplified Chinese, traditional Chinese, Korean, Russian, Arabic, Turkish, Finnish, Norwegian, Danish, Indonesian, Hungarian, Czech, Kazakh, Vietnamese, Thai, Farsi, Romania.
- **Convenient Maintenance Functions**
Lamp and filter maintenance functions provide for better and proper maintenance of the projector.
- **Security Function**
The Security function helps you to ensure security of the projector. With the Key lock function, you can lock the operation on the control panel or remote control. Passcode lock function prevents unauthorized use of the projector.
- **Colorboard Function**
At the time of simple projection on the colored wall, you can get the close color image to the color image projected on a white screen by selecting the similar color to the wall color from the preset four colors.
- **Power Management**
The Power management function reduces power consumption and maintains the lamp life.
- **Closed Caption**
This is a printed version of the program sound or other information displayed on the screen. You can turn on the feature and switch the channels.

About this user's manual

The fastest way to get started is to take your time and do everything right the first time. Take a few minutes now to review the user's manual. This may save you time later on. At the beginning of each section of the manual you'll find an overview. If the section doesn't apply, you can skip it.

3 Part Names of the Projector

Front/Top

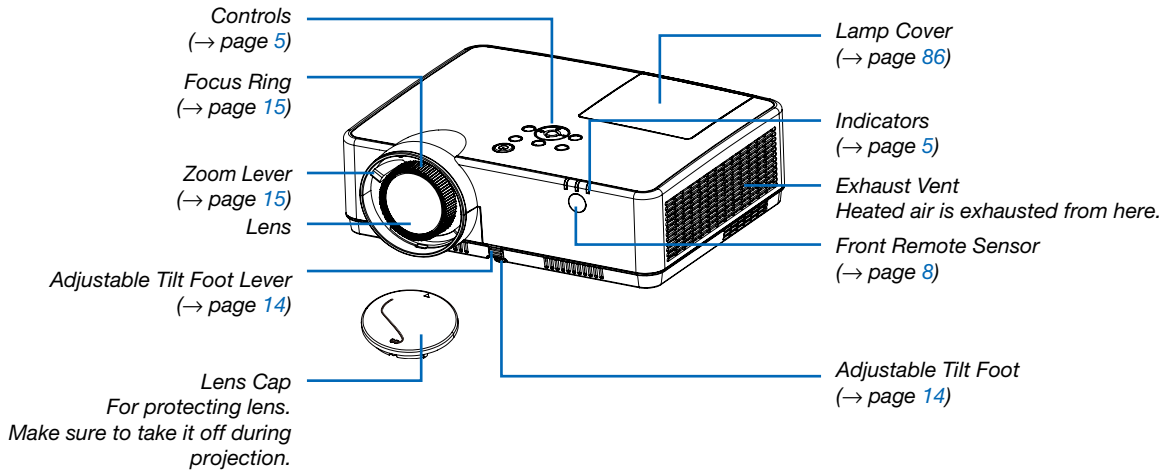

Rear

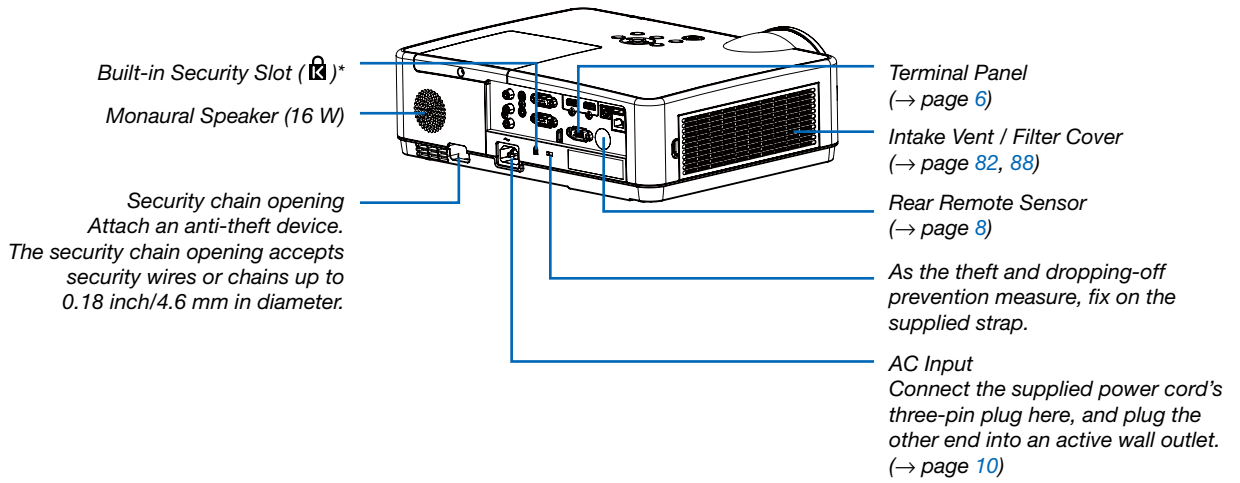

* This security slot supports the MicroSaver® Security System.

Top Features

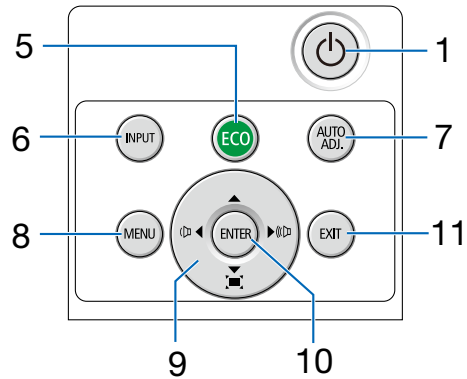
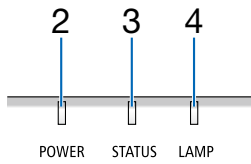

1. **⏻ (POWER) Button**
(→ page 11, 18)
2. **POWER Indicator**
(→ page 10, 11, 18, 90)
3. **STATUS Indicator**
(→ page 90)
4. **LAMP Indicator**
(→ page 90)
5. **ECO Button**
(→ page 21)
6. **INPUT Button**
(→ page 12)
7. **AUTO ADJ. Button**
(→ page 17)
8. **MENU Button**
(→ page 24)
9. **Volume Buttons ◀▶ / Keystone Buttons**
(→ page 16, 17)
10. **ENTER Button**
11. **EXIT Button**

Terminal Panel Features

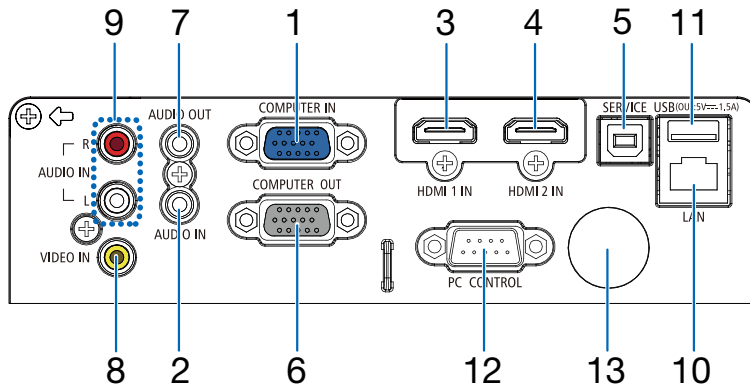

1. COMPUTER IN/ Component Input Terminal (Mini D-Sub 15 Pin)

(→ page 10, 71, 75)

2. COMPUTER AUDIO IN Mini Jack (Stereo Mini)

(→ page 71, 75)

3. HDMI 1 IN Terminal (Type A)

(→ page 71, 72, 76)

4. HDMI 2 IN Terminal (Type A)

(→ page 71, 72, 76)

5. SERVICE Port (USB Type B)

(for service purpose only)

6. COMPUTER OUT Terminal (Mini D-Sub 15 Pin)

(→ page 73)

7. AUDIO OUT Mini Jack (Stereo Mini)

(→ page 73)

NOTE: The AUDIO OUT mini jack does not support earphone/headphone terminal.

8. VIDEO IN Terminal (RCA)

(→ page 74)

9. VIDEO AUDIO IN L/MONO, R (RCA)

(→ page 74)

10. LAN Port (RJ-45)

(→ page 77)

11. USB Port (Type A)

For USB memory

(→ page 22,77)

12. PC CONTROL Port (D-Sub 9 Pin)

(→ page 98)

Use this port to connect a PC or control system. This enables you to control the projector using serial communication protocol. If you are writing your own program, typical PC control codes are on page 98.

13. Rear Remote Sensor

(→ page 8)

4 Part Names of the Remote Control

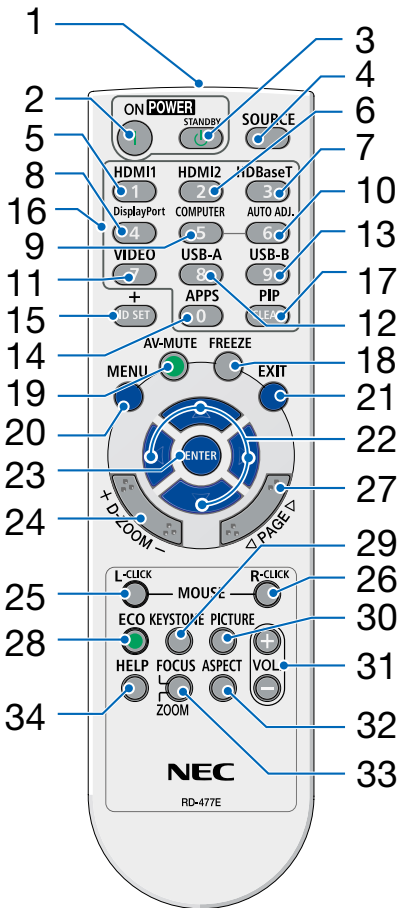

1. **Infrared Transmitter**
(→ page 8)
2. **(|) POWER ON Button**
(→ page 11)
3. **(⏻) POWER STANDBY Button**
(→ page 18)
4. **SOURCE Button**
(→ page 12)
5. **HDMI 1 Button**
(→ page 12)
6. **HDMI 2 Button**
(→ page 12)
7. **HDBaseT Button**
(This button does not work on this series of projectors)
8. **DisplayPort Button**
(This button does not work on this series of projectors)
9. **COMPUTER Button**
(→ page 12)
10. **AUTO ADJ. Button**
(→ page 17)
11. **VIDEO Button**
(→ page 12)
12. **USB-A Button**
(→ page 12, 22)
13. **USB-B Button**
(This button does not work on this series of projectors)
14. **APPS Button**
(→ page 14)
15. **ID SET Button**
(→ page 52)
16. **Numeric Keypad Button/CLEAR Button**
(→ page 52)
17. **PIP Button**
(PIP button does not work on this series of projectors)
18. **FREEZE Button**
(→ page 20)
19. **AV-MUTE Button**
(→ page 20)
20. **MENU Button**
(→ page 24)
21. **EXIT Button**
22. **▲▼◀▶ Button**
23. **ENTER Button**
24. **D-ZOOM (+)(-) Button**
(→ page 20, 21)
25. **MOUSE L-CLICK Button***
(This button does not work on this series of projectors)
26. **MOUSE R-CLICK Button***
(This button does not work on this series of projectors)
27. **PAGE ▽/△ Button**
(This button does not work on this series of projectors)
28. **ECO Button**
(→ page 38)
29. **KEYSTONE Button**
(→ page 16, 44)
30. **PICTURE Button**
(→ page 34, 35)
31. **VOL. (+)(-) Button**
(→ page 17)
32. **ASPECT Button**
(→ page 30)
33. **FOCUS/ZOOM Button**
(This button does not work on this series of projectors)
34. **HELP Button**
(→ page 56, 87)

Battery Installation

1. Press firmly and slide the battery cover off.

2. Install new batteries (AAA). Ensure that you have the batteries' polarity (+/-) aligned correctly.

3. Slip the cover back over the batteries until it snaps into place. Do not mix different types of batteries or new and old batteries.

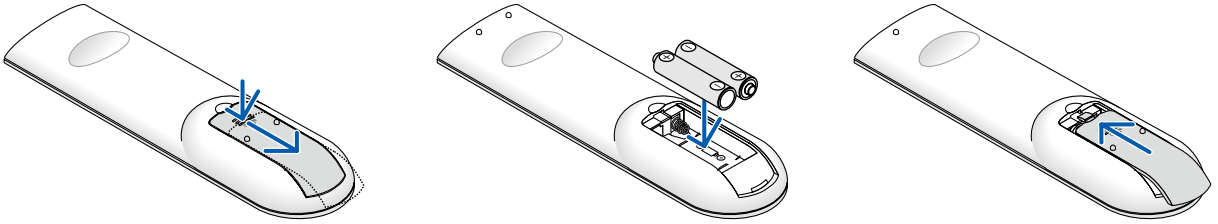

Remote Control Precautions

- Handle the remote control carefully.
- If the remote control gets wet, wipe it dry immediately.
- Avoid excessive heat and humidity.
- Do not short, heat, or take apart batteries.
- Do not throw batteries into fire.
- If you will not be using the remote control for a long time, remove the batteries.
- Ensure that you have the batteries' polarity (+/-) aligned correctly.
- Do not use new and old batteries together, or use different types of batteries together.
- Dispose of used batteries according to your local regulations.

Operating Range for Wireless Remote Control

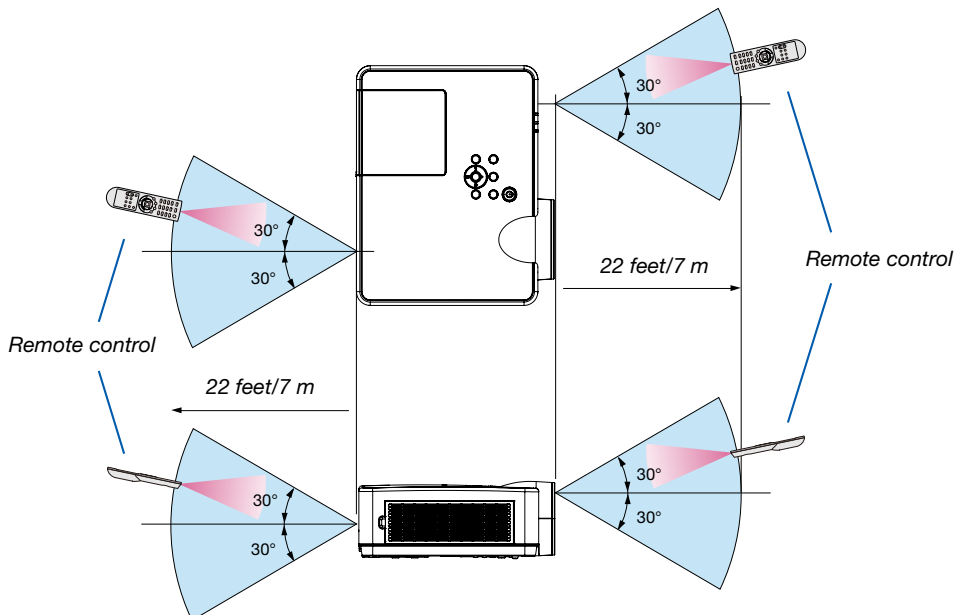

- The infrared signal operates by line-of-sight up to a distance of about 22 feet/7 m and within a 60-degree angle of the remote sensor on the projector cabinet.
- The projector will not respond if there are objects between the remote control and the sensor, or if strong light falls on the sensor. Weak batteries will also prevent the remote control from properly operating the projector.

2. Projecting an Image (Basic Operation)

This section describes how to turn on the projector and to project a picture onto the screen.

① Flow of Projecting an Image

Step 1

- *Connecting your computer / Connecting the power cord (→ page 10)*



Step 2

- *Turning on the projector (→ page 11)*



Step 3

- *Selecting a source (→ page 12)*



Step 4

- *Adjusting the picture size and position (→ page 13)*
- *Correcting keystone distortion [KEYSTONE] (→ page 16)*



Step 5

- *Adjusting a picture and sound*
 - *Optimizing a computer signal automatically (→ page 17)*
 - *Turning up or down volume (→ page 18)*



Step 6

- *Making a presentation*



Step 7

- *Turning off the projector (→ page 18)*



Step 8

- *When Moving the Projector (→ page 19)*

② Connecting Your Computer/Connecting the Power Cord

1. Connect your computer to the projector.

This section will show you a basic connection to a computer. For information about other connections, see "6. Installation and Connections" on page 71.

Connect the computer cable (VGA) between the projector's COMPUTER IN terminal and the computer's port (mini D-Sub 15 Pin). Turn two thumb screws of both terminals to fix the computer cable (VGA).

2. Connect the supplied power cord to the projector.

First connect the supplied power cord's three-pin plug to the AC IN terminal of the projector, and then connect another plug of the supplied power cord directly in the wall outlet. Do not use any plug converter.

The projector's power indicator will start blinking orange.

* This will apply for both indicators when [NORMAL] is selected for [STANDBY MODE]. See the Power Indicator section. (→ page 90)

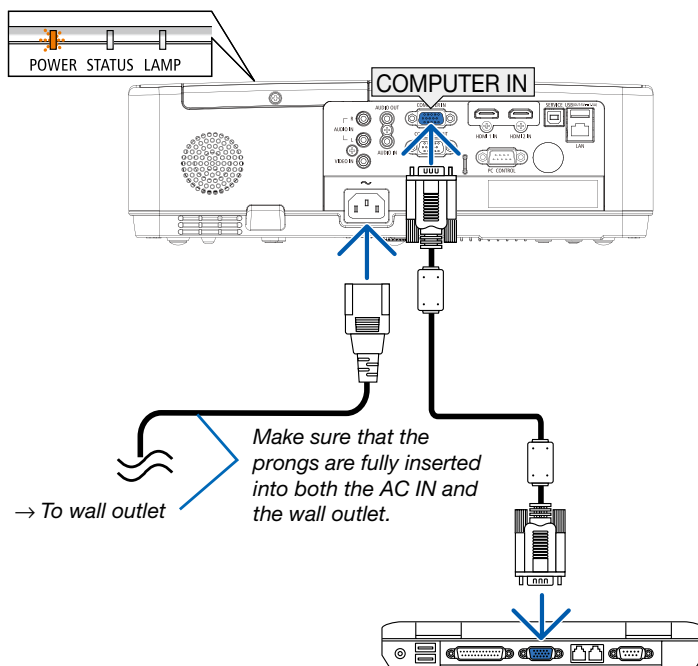

⚠ CAUTION:

Parts of the projector may become temporarily heated if the projector is turned off with the POWER button or if the AC power supply is disconnected during normal projector operation. Be careful to handle the projector.

3 Turning on the Projector

1. Remove the lens cap.

Press and hold both ends of the lens cap and pull it toward you.

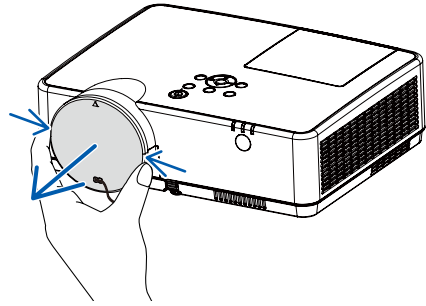

2. Press the (POWER) button on the projector cabinet or the POWER ON button on the remote control.

The POWER indicator will blink and the projector will become ready to use.

TIP:

- When the message “PIN code” is displayed, it means that the [SECURITY] feature is turned on. (→ page 49)

After you turn on your projector, ensure that the computer or video source is turned on.

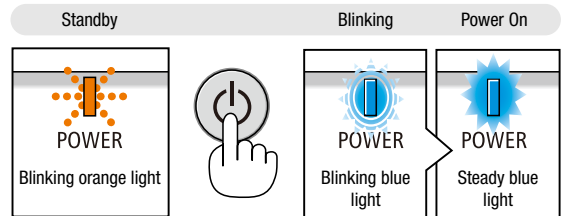
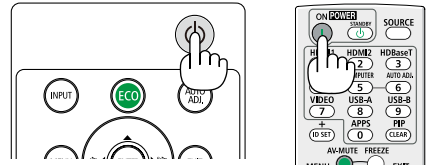

(→ page 90)

4 Selecting a Source

Selecting the computer or video source

NOTE: Turn on the computer or video source equipment connected to the projector.

Detecting the Signal Automatically

Press the INPUT button once. The projector will search for the available input source and display it. The input source will change as follows:

Computer → HDMI1 → HDMI2 → Video → USB-A → LAN

- With the INPUT screen displayed, you can press the ▲▼ button to select the input source.

TIP: If no input signal is present, the input will be skipped.

Using the Remote Control

Press any one of the Computer, HDMI1, HDMI2, Video, USB-A, or APPS buttons.

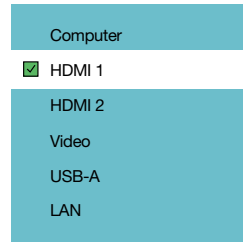
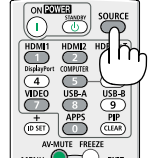
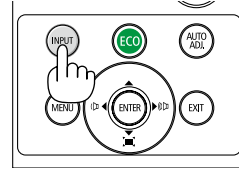

5 Adjusting the Picture Size and Position

Use the adjustable tilt foot, the zoom function or the focus ring to adjust the picture size and position.
In this chapter drawings and cables are omitted for clarity.

Adjusting the throw angle (the height of an image)
[Tilt foot] (→ page 14)

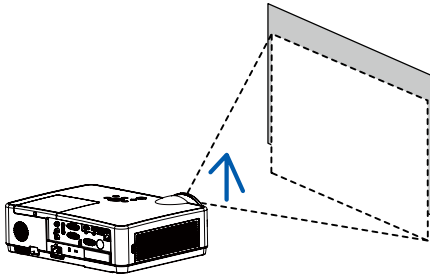

Finely adjusting the size of an image
[Zoom lever] (→ page 15)

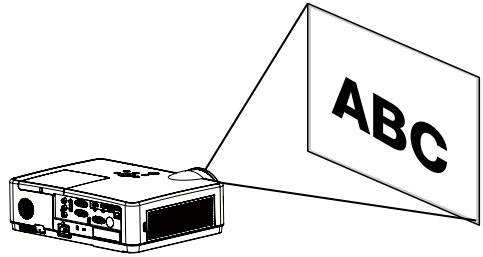

Adjusting the focus
[Focus ring] (→ page 15)

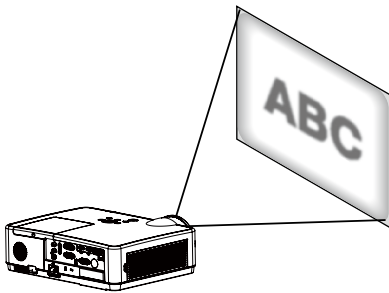

Adjusting the keystone correction [KEYSTONE]* (→ page 16)

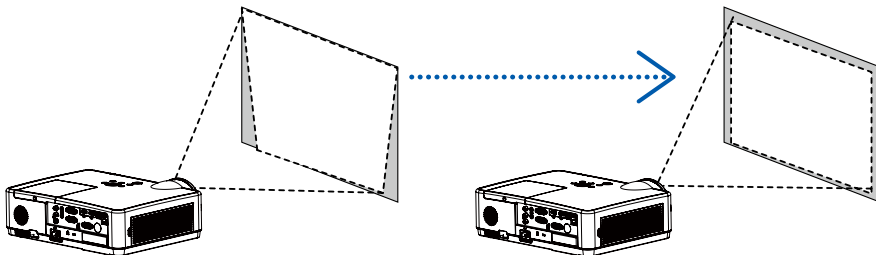

Automatic Keystone Correction function is turned on at the time of shipment.

To perform keystone correction manually, see “6. Correcting Keystone Distortion [KEYSTONE]” on page 16.

2. Projecting an Image (Basic Operation)

Adjust the Tilt Foot

1. Lift the front edge of the projector.

⚠ CAUTION:

Do not try to touch the exhaust vent during Tilt Foot adjustment as it can become heated while the projector is turned on and after it is turned off.

2. Push up and hold the Adjustable Tilt Foot Lever on the front of the projector to extend the adjustable tilt foot.

3. Lower the front of the projector to the desired height.

4. Release the Adjustable Tilt Foot Lever to lock the Adjustable tilt foot.

The tilt foot can be extended up to 1.6 inch/40 mm.

There is approximately 10 degrees (up) of adjustment for the front of the projector.

⚠ CAUTION:

- Do not use the tilt-foot for purposes other than originally intended. Misuses such as using the tilt foot to carry or hang (from the wall or ceiling) the projector can cause damage to the projector.

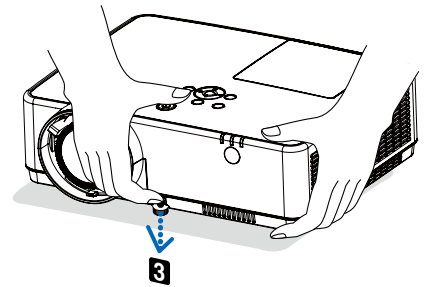
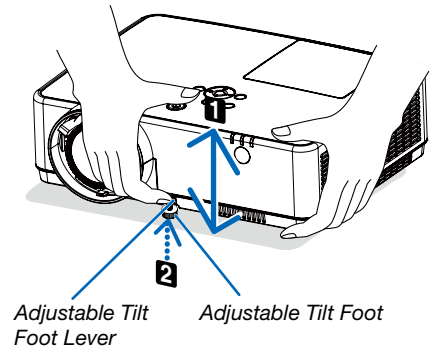

2. Projecting an Image (Basic Operation)

Zoom

Use the ZOOM lever to adjust the image size on the screen.

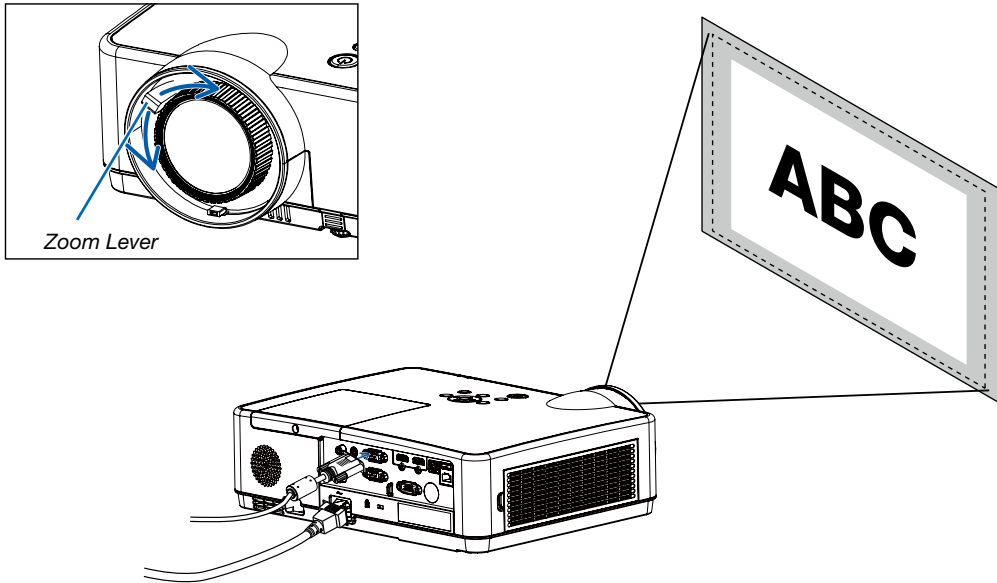

Focus

Use the FOCUS ring to obtain the best focus.

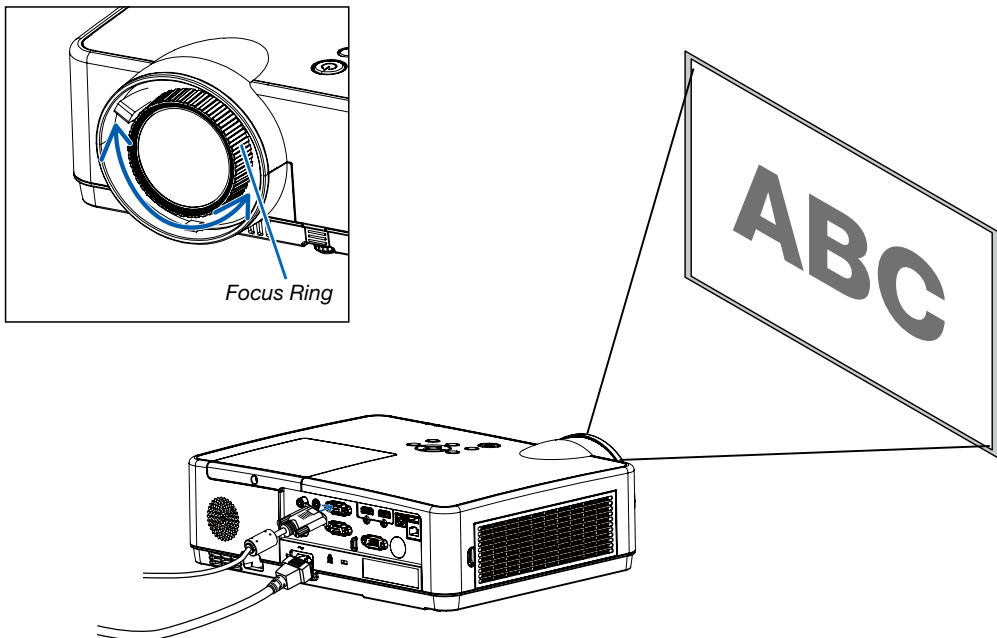

⑥ Correcting Keystone Distortion [KEYSTONE]

You may adjust keystone distortion of image in your projector with the V keystone adjustment. Follow steps below to adjust keystone distortion of projected image manually.

Press the KEYSTONE button on your remote controller. The keystone adjustment dialog box displays (including H/V keystone, 4-Corner correction, 6-Corner correction, Curved correction, Grid Image Tune, Reset) , press ▲▼◀▶ button to adjust keystone distortion.

You may save your settings for keystone adjustment.

- H/V Keystone.....Adjust the projected image when the projector is on the horizontal or vertical keystone distortion.
- 4-Corner correction.....Adjust the projected image when the projector is keystone distortion of four corners .
- 6-Corner correction.....Adjust the projected image when the projector is keystone distortion of four corners.
- Curved correction.....Adjust the projected image when the projector linearity is uneven or the projected images bent vertically and horizontally.
- Grid Image Tune.....Adjust the local points of the projected image.
- Reset.....The correction values will be restored to the factory defaults.

NOTE:

- The arrow mark looks white when there is no keystone adjustment in existence.
 - The arrow mark indicating the adjustment direction turns red.
 - The arrow mark disappears when the maximum adjustment limit reaches.
 - The keystone prompt box will disappear if you press the keystone button again when it is displaying. Press the ENTER button again to switch the four correction items.
 - The adjustable range is subject to source of signal input.
 - For further details about Keystone function, please turn to page 44-48.
 - When using the VIEWER, you cannot use ▼ button on the panel to directly call up the keystone correction menu.
-

H/V Keystone

4-Corner correction

6-Corner correction

Curved correction

Grid Image Tune

Reset value

- Only for ME403U

H/V Keystone

4-Corner correction

Reset value

- Only for ME423W/ME383W/MC423W/MC393W/ME453X/MC453X.

7 Optimizing Computer Signal Automatically

Adjusting the Image Using Auto Adjust

Optimizing a computer image automatically. (COMPUTER)

Press the AUTO ADJ. button to optimize a computer image automatically. This adjustment may be necessary when you connect your computer for the first time.

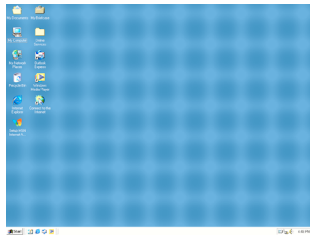
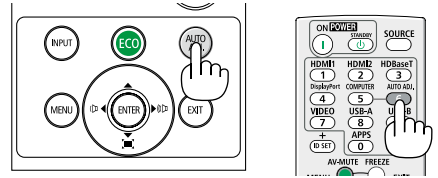

[Poor picture]

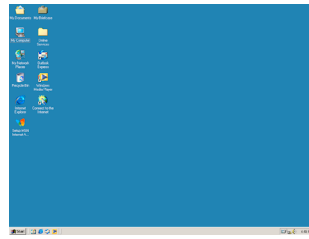

[Adjusted picture]

NOTE:
Some signals may take time to display or may not be displayed correctly.
• If the Auto Adjust operation cannot optimize the computer signal, try to adjust [Fine sync], [H position], [V position], and [H. size] manually.
(→ page 30, 31)

8 Turning Up or Down Volume

Sound level from the speaker or audio output can be adjusted.

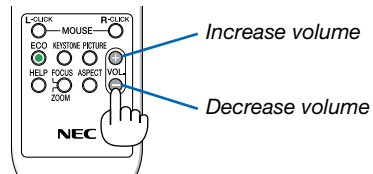

TIP: When no menus appear, the ◀ and ▶ buttons on the projector cabinet work as a volume control.

When the above volume adjustment menu appears, press ▲ and ▼ buttons to control the mute on and off.

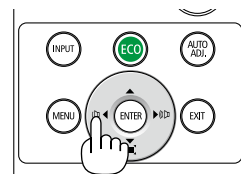

NOTE:
• Volume control is not available with the ◀ or ▶ button when an image is magnified by using the D-ZOOM (+) button or when the menu is displayed.
• Volume control is not available with the ◀ or ▶ button when VIEWER is used.

9 Turning off the Projector

To turn off the projector:

1. First, press the  (POWER) button on the projector cabinet or the STANDBY button on the remote control.

The confirmation message will be displayed.

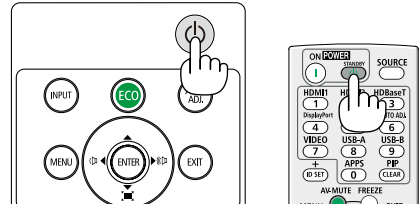
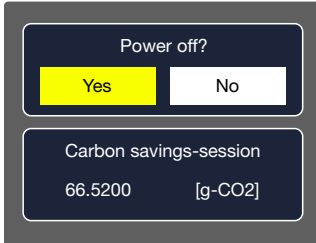

2. Secondly, press the ENTER button or press the  (POWER) or the STANDBY button again.

The lamp will turn off and the projector will go into standby mode. When in standby mode, the POWER indicator will be blinking orange and the STATUS indicator will turn off when [Normal] is selected for [STANDBY MODE].

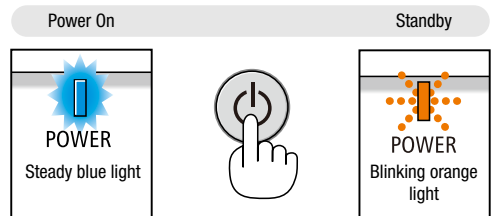

CAUTION:

Parts of the projector may become temporarily heated if the projector is turned off with the POWER button or if the AC power supply is disconnected during normal projector operation.
Use caution when picking up the projector.

NOTE:

- While the power indicator is blinking blue in short cycles, the power cannot be turned off.
- You cannot turn off the power for 60 seconds immediately after turning it on and displaying an image.
- Do not disconnect the AC power supply to the projector within 10 seconds after making adjustment or setting changes and closing the menu. Doing so can cause loss of adjustments and settings.

10 When Moving the Projector

Preparation: Make sure that the projector is turned off.

1. *Put on the lens cap.*
2. *Unplug the power cord.*
3. *Disconnect any other cables.*
 - *Remove the USB memory if it is inserted into the projector.*
(→ page [22,77](#))

3. Convenient Features

1 Turning off the Image and Sound

Press the AV-MUTE button to turn off the image and sound for a short period of time. Press again to restore the image and sound.

The projector's power-saving function will work 10 seconds after the image is turned off.

As a result, the lamp power will be reduced.

NOTE:

- Even though the image is turned off, the menu still remains on the screen.
- Sound from the AUDIO OUT jack (Stereo mini) can be turned off.
- Even when the power-saving function works, the lamp power may be restored to its original level temporarily.
- To restore the image, even if you press the AV-MUTE button immediately after the start of the power-saving function, the lamp brightness may not be restored to its original level.

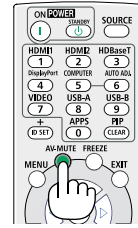

2 Freezing a Picture

Press the FREEZE button to freeze a picture. Press again to resume motion.

NOTE: The image is frozen but the original video is still playing back.

- This feature can not be used when LAN, and USB-A is selected as the input terminal.

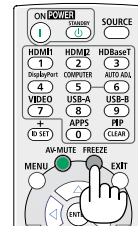

3 Magnifying a Picture

You can enlarge the picture up to four times.

NOTE:

- The maximum magnification may be less than four times depending on the signal.
- This feature can not be used when LAN, and USB-A is selected as the input terminal.

To do so:

1. Press the D-ZOOM (+) button to magnify the picture.

To move the magnified image, use the ▲, ▼, ◀ or ▶ button.

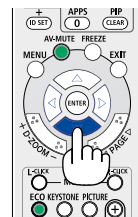
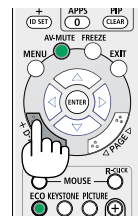
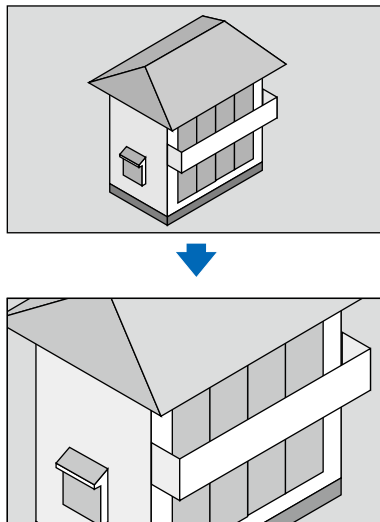

2. Press the ▲▼◀▶ button.

The area of the magnified image will be moved.

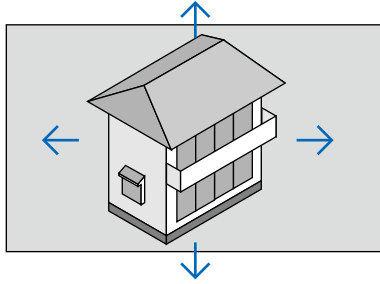

4. Using the VIEWER

Memory viewer function

When the USB memory is inserted into the projector, the viewer memory function can project the video and pictures stored in the USB memory.

The projected content of memory viewer function

Memory viewer function supports the following picture files.

	Extension name	Format	Description
Maps	jpg/jpeg	Baseline encoder 24	Max resolution: 10000x10000
		Progressive RGB24 bit	Max resolution: Panel Resolution
	bmp	1.4.8 bit palette-based RGB24,32 bit	Max resolution: 1280X800
	png	24, 48-bit True Color	
	gif	1,4,8-bit palette-based	
	tiff		

Display memory viewer screen

When the USB memory is inserted into the projector, the viewer memory function can project the video and pictures stored in the USB memory.

- 1) Press INPUT button on the remote controller and on the top control panel and select the input source of [USB-A].
- 2) Insert the USB memory into the <USB-A> terminal directly.
 - Press RC enter to display standby screen instantly, while the USB memory icon displays in the left corner of the screen.
 - When the USB memory is independent of the partition, it will display more than one USB icon.
- 3) Press ▲▼ button to switch required items.
 - The root directory of the USB memory is displayed in a thumbnail.

Play image

Only one image shows on the screen when you play it.

- 1) Press ◀▶ button to select a file.
- 2) Press <ENTER or ▶> button.
 - Full screen display
- 3) Press <ENTER > button.
 - Press <ENTER> to return the thumbnail.

Play slide

The slide show mode in the USB-A menu is set to a special setting, all images in the same folder can play automatically.

- 1) Press ◀▶ button to select a file.
- 2) Press ▲▼ button to select [USB-A] menu, then select [Set slide] menu.
- 3) Press <ENTER > button.
 - Full screen display
 - Press <ENTER> button to return the thumbnail.

The termination of memory viewer

The slide show mode in the USB-A menu is set to a special setting ,all images in the same folder can play automatically.

- 1) Press ◀▶ button to select  , displayed in the left corner of the screen.
- 2) Press <ENTER > button.
- 3) Unplug the USB memory directly.

NOTE:

- Only USB memory up to FAT32 (32GB) can be read.
- When you insert a USB memory, please make sure insertion direction to avoid damaging the port.
- Please note the following points when inserting and removing USB memory:
 - a. The indicator flashes,when the USB memory insert into the projector or the projector is reading data.do not remove the USB memory When the light is flashing.
 - b. If you use a USB memory device without indicator, the projector will not recognize when reading data. Please close its browse function on and turn off the projector , then remove the USB memory.
 - c. Do not insert and remove USB memory frequently. Then remove it after the installation of at least 5 seconds. After removing at least 5 seconds and then reinsert it.
 - d. Due to the file format, some pictures cannot display thumbnails.

Precautions on processing and storage of USB memory

- If smoke or produce abnormal smell, close the external device and contact the dealer.
 - Do not put foreign matter or metal items in the USB port. Static electricity may cause data loss or data damage.
-

5. Using On-Screen Menu

① Menu item overview

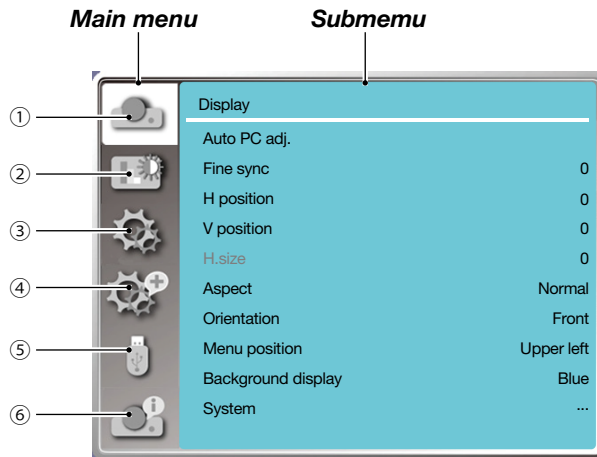

1. Display menu

- **Select Auto PC adj., Fine sync, H position, V position, H. size to adjust the parameters to match the VGA format.**
- **Aspect: XGA(Normal/Wide/Full/16:10), WXGA/WUXGA(Normal/Wide/Full/4:3).**
---Video signal only supports Normal/Wide.
- **Orientation: Choose Front, Auto ceiling/Rear, Auto ceiling/Front, Ceiling / Rear, Ceiling / Front and Rear.**
- **Menu position: Set screen menu display position on the screen.**
- **Background display: Sets the background color of the projection screen.**
- **Signal format: Select the compatible system signal format with input source.**

2. Color adjust menu

Available options in the Image mode menu are **Dynamic, Standard, Cinema, Blackboard (Green), Colorboard, or User image.**

- **For video signal input, the available color adjust options: Contrast, Brightness, Color, Tint, Red, Green, Blue and Sharpness.**
- **For other signal input, the available color adjust options: Contrast, Brightness, Color temp. , Red, Green, Blue and Sharpness.**

3. Setting menu

Configuration of the basic function operation on the projector: On start, Standby mode, High altitude, ECO mode, Cooling fast, Closed caption, Key lock, Iris, Baud rate, Sound and HDMI setup.

4. Expand menu

Available adjust options are Language, Auto setup, Keystone, Security, Power management, Filter, Test pattern, Network setup, Control ID, Factory default and Lamp counter reset.

5. USB-A menu

Select parameter of Set slide, Slide transition effect, Sort order, Rotate, Best fit, Repeat, Apply.

6. Information menu

Display information about the projector.

② List of Menu Items

Some menu items are not available depending on the input source.

Main menu	Sub-menu	Setting	Remarks	
Display	Auto PC adj.			
	Fine sync	0-31		
	H position	-5 - +5		
	V position	-5 - +5		
	H. Size	-15 - +15	The range of H. size differs from signals.	
	Aspect	XGA	Normal*/Wide/ Full/16:10	Video signal only supports Normal/Wide.
		WXGA/WUXGA	Normal*/Wide/ Full/4:3	
	Orientation	Front * Rear Ceiling / Front Ceiling / Rear Auto ceiling / Front Auto ceiling / Rear		
	Menu position	Upper left* Upper right Center Lower left Lower right		
	Background display	Black,Blue*,Logo		
Signal format	AUTO* PAL SECAM NTSC NTSC4.43 PAL-M PAL-N PAL-60	Video Input		
Color adjust	Image mode	Standard* Cinema Blackboard(Green) Colorboard User image Dynamic		
	Contrast	0-63		
	Brightness	0-63		
	Color temp	High/Mid/Low/User	Computer/HDMI Input	
	Color	0-63	Video Input	
	Tint	0-63	Video Input	

* The asterisk (*) indicates that the default setting varies depending on the signal.

5. Using On-Screen Menu

Main menu	Sub-menu	Setting	Remarks	
Color adjust	Red	0-63		
	Green	0-63		
	Blue	0-63		
	Sharpness	0-15		
Setting	On start	On/Off*		
	Standby mode	Normal*/Sleep/Network standby		
	High altitude	On/Off*		
	ECO mode	Normal*/ECO1/ECO2/Boost		
	Cooling fast	Normal*/0 Sec/30 Sec		
	Closed caption	Off*/CC1/CC2/CC3/CC4		
	Key lock	On/Off*		
	Iris	On/Off*		
	Baud rate	19200/4800/38400/9600		
	Sound	Volume	0-25	
		Mute	On/Off*	
	HDMI setup	Image	Auto/64-940/ 0-1023	
		Sound	HDMI*/ Computer	
HDMI EQ setup		0*/1/2/3		
Expand	Language	Projector provides multiple language support		
	Auto setup	Input search	On*/Off	
		Auto PC adj.	On/Off	
		Auto keystone	On/Off*	
	Keystone	Keystone	Store* / Reset	
		H/V keystone		
		4-Corner correction		
		6-Corner correction*1		
		Curved correction*1		
		Grid image tune*1		
		Reset		
	Security	PIN code lock	On/Off*	
PIN code change				

* The asterisk (*) indicates that the default setting varies depending on the signal.

*1 This feature is not supported by ME423W/ME383W/MC423W/MC393W/ME453X/MC453X.

5. Using On-Screen Menu

Main menu	Sub-menu	Setting	Remarks	
	Power management	Ready* Shut down Off Timer Ready countdown		
	Filter	Filter counter Timer Filter counter reset Filter clogging check		
	Test pattern	Off, Gray scale (1-4), Color bar, Red, Green, Blue, Cross hatch, White, Black, Raster gray		
	Network setup	Wired LAN	DHCP(On/Off) IP address Subnet Gateway DNS	
		Wireless LAN	Setting(On/Off)	
	Control ID	Control ID	On/Off	
		Control ID number	1-254	
	Factory default			
Lamp counter reset				
Memory Viewer	Set slide			
	Slide transition effect	Slide down Slide right*		
	Sort order	Extend order Name order* Time order Size order		
	Rotate	No rotate* 270° degree 180° degree 90° degree		
	Best fit	On/Off*		
	Repeat	On/Off*		
	Apply			
Info.	Input			
	H- sync freq.			
	V- sync freq.			
	Lamp counter			
	Model name			
	S/N			
	Firmware version			
	SUBCPU			

* The asterisk (*) indicates that the default setting varies depending on the signal.

③ Menu Descriptions & Functions [INPUT]

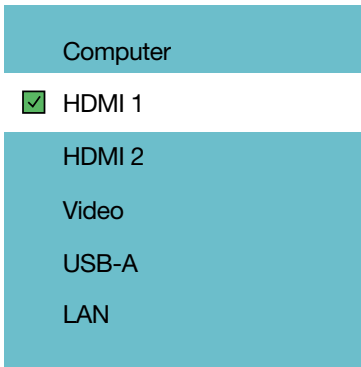

Computer

Selects the computer connected to your Computer input terminal signal.

NOTE: When the component input signal is connected to the COMPUTER IN terminal, select [Computer].

HDMI1 and HDMI2

Selects the HDMI compatible equipment connected to your HDMI1 or 2 IN terminal.

Video

Selects what is connected to your Video input-VCR, DVD player or document camera.

USB-A

This feature enables you to make presentations using a USB memory that contains slides.
(→ page 22 “4. Using the VIEWER”)

LAN

Selects a signal from the LAN port (RJ-45).

④ Menu Descriptions & Functions [Display menu]

[Auto PC adj.]

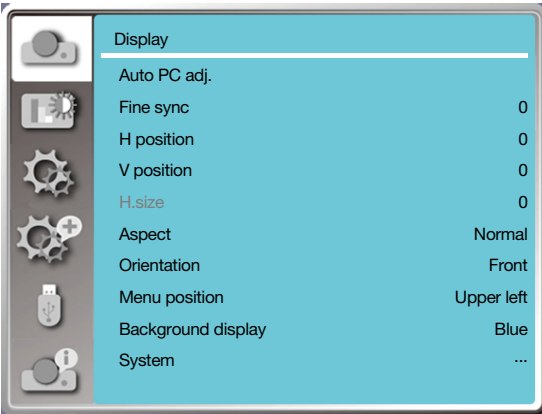

Select Auto PC Adj. function can adjust Fine sync, H position, V position, H. size to be compatible with the computer automatically.

Press < MENU > button on the remote controller or on the top control panel to display the OSD menu.

Press ▲ ▼ button to select the Display menu, then press < ENTER > or ► button.

- 1) Press ▲ ▼ button to select [Auto pc adj.] menu.
- 2) press < ENTER > button.

NOTE:

- The projector will perform Auto PC Adjustment function automatically, when its signal is input for the first time.
 - Auto PC Adjustment function may fail to work if computer models is not compatible with the input signal.
 - Auto PC Adjustment function may fail to work if you select the following system signal format: 480i, 576i, 480p, 576p, 720p, 1080i, 1080p, or signals from the HDMI terminal.
-

[Fine sync]

(Only for PC signal input)

Adjust image to the best state when the image jitters, or the image outline dims.

- 1) Press ▲ ▼ button to select [Fine sync] menu.
- 2) Press < ENTER > button.
- 3) Press ▲ ▼ button to adjust Fine sync.

Adjustment range is from 0 to +31. Please adjust to the least interference state.

[H position]

(Only for PC signal input)

On the premise that the relative position of both projector and the screen is set up right, you can move the image horizontal position, if the position of the projected image on the screen is deviated.

- 1) Press ▲ ▼ button to select [H position] menu.
- 2) Press < ENTER > button.
- 3) Press ▲ ▼ button to adjust image H position.

Adjustment range is from -5 to +5.

[V position]

(Only for PC signal input)

On the premise that the relative position of both projector and the screen is set up right, you can move the image vertical position, if the position of the projected image on the screen is deviated.

- 1) Press ▲▼ button to select [V position] menu.
- 2) Press <ENTER> button.
- 3) Press ▲▼ button to adjust image V position.

Adjustment range is from -5 to +5.

[H. size]

(Only for PC signal input)

You can adjust and reduce the interference caused by patterns of the projected vertical stripes. The following projected patterns may cause a circular pattern (Noise). Adjust the amount of interference to the minimum. Users can point the clock to adjust images.

- 1) Press ▲▼ button to select [H. size] menu.
- 2) press <ENTER> button.
- 3) Press ▲▼ button to adjust H. size level .

Adjustment range is from -15 to +15.

[Aspect]

Adjust the image to fit the screen size, while keeping aspect of input signal's unchanged.

Press < MENU > button on the remote controller or on the top control panel to display the OSD menu. Press ▲▼ button to select the Display menu, then Press <ENTER> or ► button.

- 1) Press ▲▼ button to select [Aspect] menu.
- 2) Press <ENTER> button.
- 3) Press ▲▼ button to select the required item.

Normal..... Use the maximum size to roject while keeping the aspect of input signal's unchanged.

Wide.....Project images at the aspect of 16: 9.

Full.....Project images to the maximum.

4:3.....Project images at the aspect of 4:3.

16:10.....Project images at the aspect of 16:10.

NOTE:

- Aspect: XGA(Normal/Wide/Full/16:10), WXGA/WUXGA(Normal/Wide/Full/4:3).
- Video signal only supports Normal/Wide.

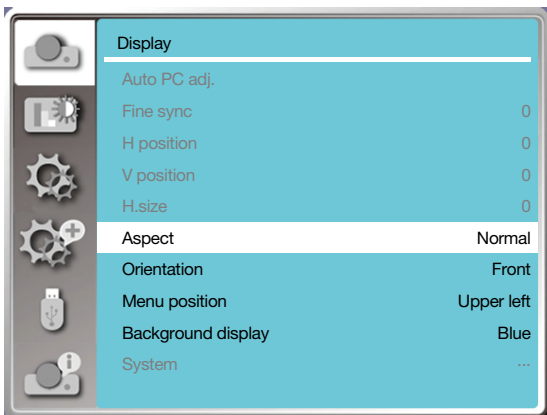

[Orientation]

Select this function to set the project way.

Please change the projection way, if the OSD displays inversely or reversedly.

Press < MENU > button on the remote controller or on the top control panel to display the OSD menu. Press ▲ ▼ button to select the Display menu ,then press <ENTER> or ► button.

1) Press ▲ ▼ button to select [Orientation] menu.

2) Press <ENTER> button.

3) Press ▲ ▼ button to switch.

Front: when the projector is installed on the table and projected in front of the screen.

Rear: when the projector is installed on the table and projected in rear of the screen (using translucent screen)

Ceiling / Front: when use the bracket to lift the projector (optional) in front of the screen.

Ceiling / Rear: when use the bracket to lift the projector (optional) in rear of the screen(using translucent screen).

Auto ceiling / Front: when the projector is projected in front of the screen.

Auto ceiling / Rear: when the projector is projected in rear of the screen.

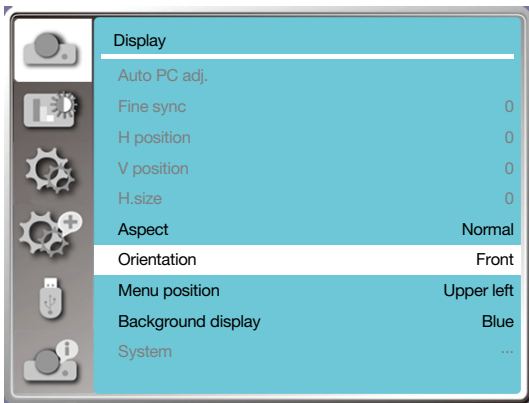

[Menu position]

Select this function to set the OSD Menu position.

Press < MENU > button on the remote controller or on the top control panel to display the OSD menu. Press ▲ ▼ button to select the Display menu ,then press <ENTER> or ► button.

1) Press ▲ ▼ button to select [Menu position] menu.

2) Press <ENTER> button.

3) Press ▲ ▼ button to change menu position.

Upper leftThe menu display on the upper left corner of the screen.

Upper rightThe menu display on the upper right corner of the screen.

Center.....The menu display in the center of the screen.

Lower leftThe menu display on the lower left corner of the screen.

Lower rightThe menu display on the lower right corner of the screen.

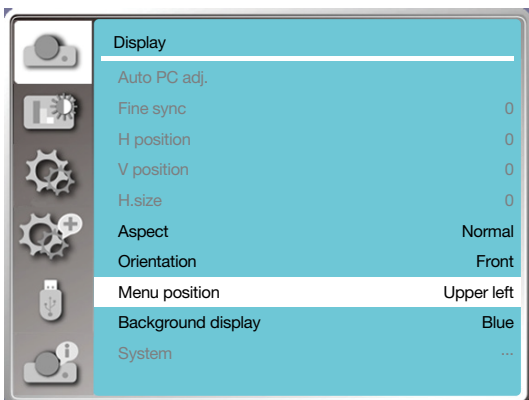

[Background display]

Select this function can adjust background color.

Press < MENU > button on the remote controller or on the top control panel to display the OSD menu. Press ▲ ▼ button to select the Display menu ,then press <ENTER> or ► button.

1) Press ▲ ▼ button to select [Background display] menu.

2) Press <ENTER> button.

3) Press ▲ ▼ button to select required item .

Blue..... The entire projection area display blue.

Black.....The entire projection area display black.

Logo.....The entire projection area display PROJECTOR background.

NOTE:

- This function will be invalid once you select input signal as USB-A and LAN.

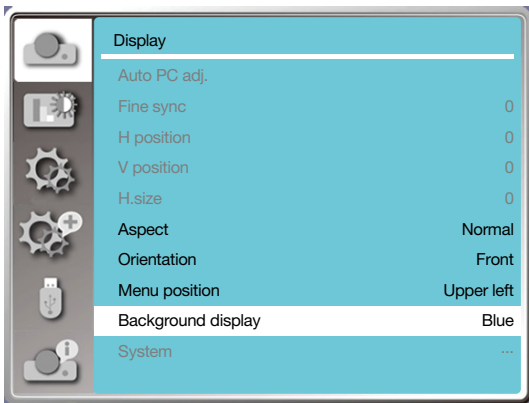

[Signal format]

If a PC is selected as the input signal source, your projector will detect and adapt to its signal format automatically. Correct image can be displayed without any setup operation.

Your projector will display one of the following:

Auto: The Auto PC Adjusting function will make necessary adjustment to your projector to project valid images. If images are displayed incorrectly, adjust it manually.

---- : No PC signals detected. Check the connection between PC and your projector.

NOTE:

- Your projector may save data generated by the Auto PC Adjusting function.

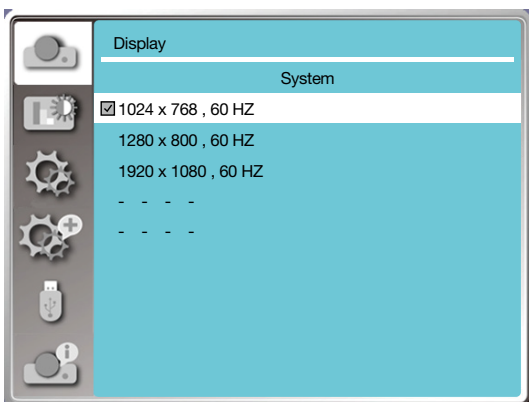

- The selected Signal format displays in the Signal format menu.

Select the computer Signal format manually.

1. Press the MENU button on remote controller and the OSD displays. Press ◀▶ button to point to the Input icon, press ▲▼ button or ENTER button and the Input menu displays.
2. Press ▲▼ button to select Signal format, then press ENTER button.

NOTE:

- The computer Signal format menu will be disabled once HDMI 1, HDMI 2, USB-A, LAN has been selected.

Video

Select this function to set resolution of input signal is compatible with the PC.

Set video input signal color Signal format or component input signal scanning mode.

- 1) Press ▲▼ button to select [Signal format] menu.
- 2) Press <ENTER> button.
- 3) Press ▲▼ button to select wanted Signal format.

Computer input signal

1024x768 60HZ, etc:display the compatible name input signal name.

Auto: When projector has no compatible input signal with one from connected PC, the PC can adjust automatically to run and Auto appear on the Signal format. If the image is not projected out correctly, please adjust it to match your computer manually.

- - - -: No signal input come from PC. Please check the connections.

Video input signal

AUTO: When projector select the input signal color Signal format automatically. set [PAL-M] or [PAL-N] manually . [PAL]/[SECAM]/[NTSC]/[NTSC4.43]/[PAL-M]/[PAL-N]/[PAL60]:When projector can not display images correctly in [AUTO], please set input signal color Signal format manually.

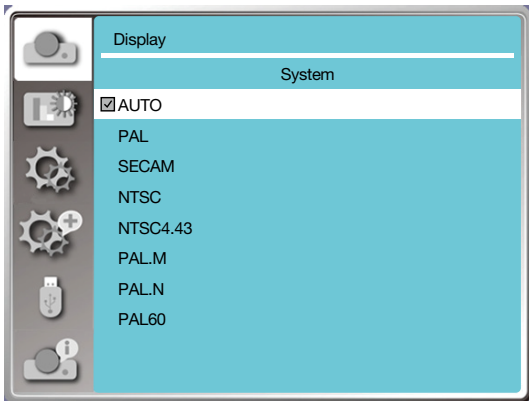

- Signal format menu, when Video input.

5 Menu Descriptions & Functions [Color adjust]

Select color adjustment to set the image mode and adjust the quality of the projected image.

[Image mode]

Direct operation

Press the PICTURE select button on remote controller to select required image mode.

Menu operation

Press < MENU > button on the remote controller or on the top control panel to display the OSD menu. Press ▲ ▼ button to select the color adjust menu ,then press <ENTER> or ► button.

- 1) Press ▲ ▼ button to select [Image mode] menu.
- 2) Press <ENTER> button.
- 3) Press ▲ ▼ button to select required item.

Dynamic

An image mode suitable for viewing in bright room.

Standard

The default mode of your projector ,can come to national color.

Cinema

Enriched grayscale for viewing movies.

Blackboard (Green)

An image mode designed for displaying on a blackboard (Green). It boosts quality of image projected on blackboard (Green). This is designed for a board in green rather than black as indicated by its name.

Colorboard

A image mode suitable for image projecting on surface of wall in red, blue, yellow or green.press <ENTER> button. to enter colorboard menu, then press ▲ ▼ button to select Red ,Blue ,Yellow or Green,press <ENTER> button.

User image

Users can customize the color adjustment.

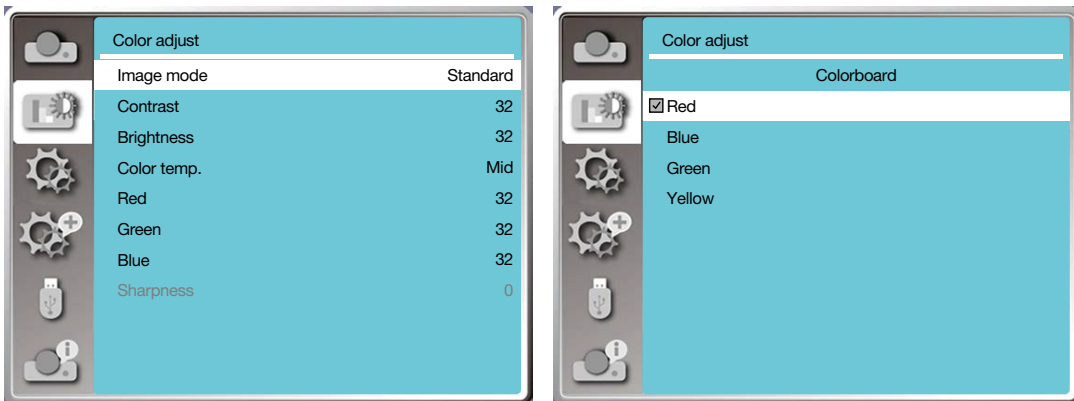

[Color adjust]

Press < MENU > button on the remote controller or on the top control panel to display the OSD menu. Press ▲ ▼ button to select the Color adjust menu ,then press <ENTER> or ► button.

- 1) Press ▲ ▼ button to select required item.
- 2) Press <ENTER> button.
- 3) Press ▲ ▼ button to select adjust setpoint.

Contrast

Press ▼ button to decrease contrast, range from 0 - +63.

Press ▲ button to increase contrast, range from 0 - +63.

Brightness

Press ▼ button to decrease brightness, range from 0 - +63.

Press ▲ button to increase brightness, range from 0 - +63.

Color temp. (For PC/HDMI input)

Press ▲ ▼ button to select required color temperature (Low, Mid. and High)

High temp: Become blue gradually.

Mid temp: Suitable natural color.

Low temp: Become red gradually.

User: You can adjust the Red, Green, and Blue values by yourself.

Color (For Video input)

Press ▼ button to decrease saturation, press ▲ button to increase saturation.

Tint. (For Video input)

Press ▲ ▼ button to select required tint.

Red

Press ▼ button to decrease red tint and ▲ button to increase it.

Green

Press ▼ button to decrease green tint and ▲ button to increase it.

Blue

Press ▼ button to decrease blue tint and ▲ button to increase.

Sharpness

Press ▼ button to soften image and ▲ button to sharpen, range from 0 - +15.

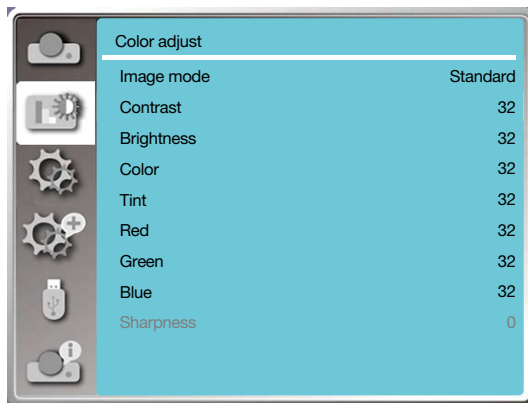
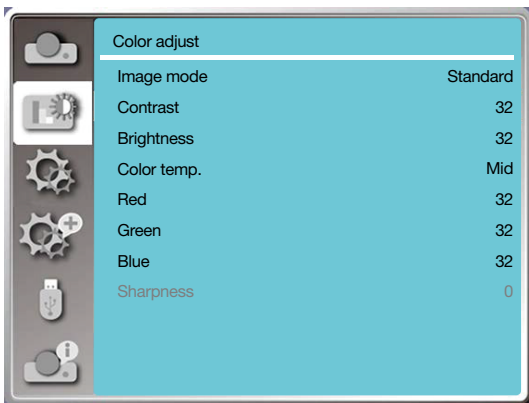

6 Menu Descriptions & Functions [Setting]

The projector has setting function, you can select other functions as described below.

Menu operation

Press < MENU > button on the remote controller or on the top control panel to display the OSD menu. Press ▲ ▼ button to select the setting menu ,then press <ENTER> or ► button.

- 1) Press ▲ ▼ button to select required item.
- 2) Press <ENTER> button.
- 3) Press ▲ ▼ button to set options.

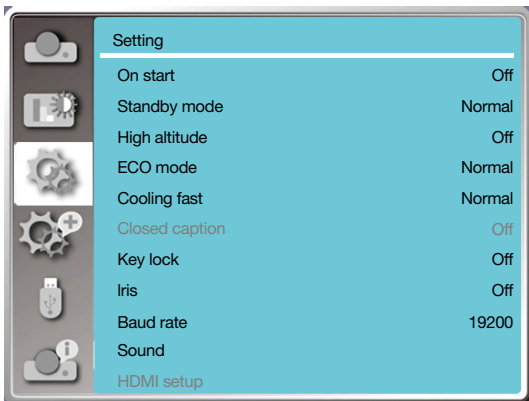

[On start]

Set the power mode on , when the power cord is connected to a power outlet.

- 1) Press ▲ ▼ button to select [On start] menu.
- 2) Press <ENTER> button.
- 3) Press ▲ ▼ button to select required item.

Off..... Get into standby mode.

On.....Start up immediately.

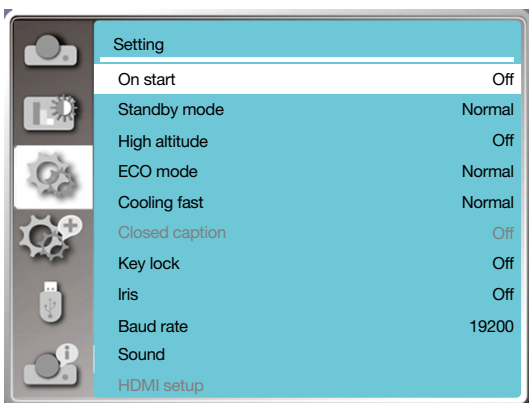

[Standby mode]

Set power consumption in standby mode, no matter whenever your projector is operated through network.

- 1) Press ▲ ▼ button to select [Standby mode] menu.
- 2) Press <ENTER> button.
- 3) Press ▲ ▼ button to adjust levels.

Normal.....Some function will be disabled once your projector is in ECO. standby mode to reduce power consumption. network and RS-232C serial communication will be unavailable except the power on command during that mode.

Network standby.....In order to reduce power consumption, some functions in standby mode will be limited. Under network standby, network function is not available and RS-232C serial communication (except boot command) function is not available.

- Standby mode network wake-up function can only use the "Wake On LAN" tool.

SleepEven in standby mode,there are no restraint on network function and serial communication function.

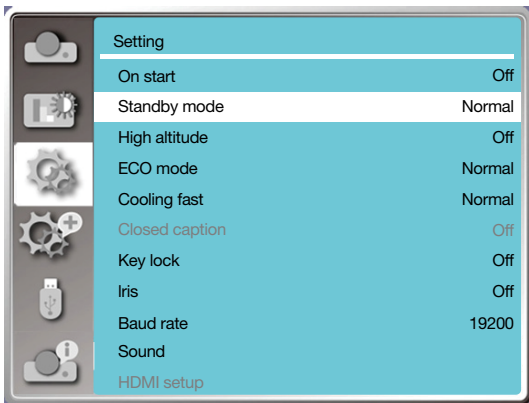

[High altitude]

You can change the setting about speed of cooling fan according to the altitude your projector is operating at.

- 1) Press ▲ ▼ button to select [High altitude] menu.
- 2) Press <ENTER> button.
- 3) Press ▲ ▼ button to select required menu.

Off: Normal speed. set the option off when operating the operator, if the altitude is not too high.

On: Faster than when in off mode .set the option on when operating the operator in high land.

Note:

- Set high altitude option on when you operate the operator at an altitude of approximately 1700 m/5500 f or higher.

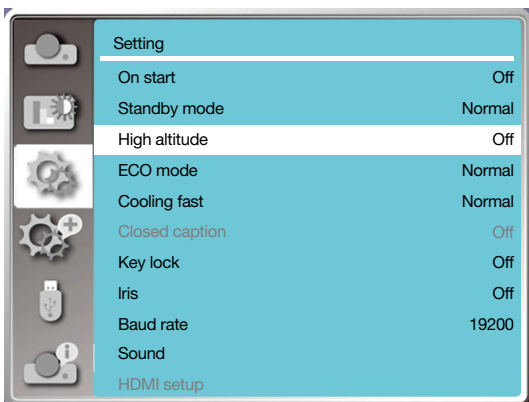

[ECO mode]

Change lamp brightness according to the environment and aim your projector is operating.

- 1) Press ▲▼ button to select [ECO mode] menu.
- 2) Press <ENTER> button.
- 3) Press ▲▼ button to switch required menu.

Normal.....Normal brightness.

ECO 1/ECO 2.....Lower the brightness and reduce energy consumption, thus prolonging the light source service life.

Boost.....Enhance brightness.

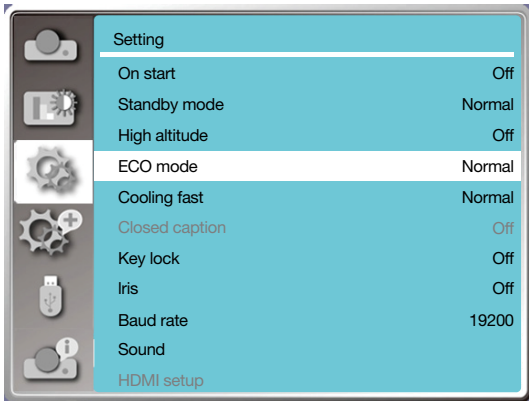

[Cooling fast]

Select the cooling time after projector is turned off.

- 1) Press ▲▼ button to select [Cooling fast] menu.
- 2) Press <ENTER> button.
- 3) Press ▲▼ button to switch required menu.

Normal.....Running in normal way.

30 Sec.....Running faster than in normal mode with shorter time but a louder sound.

0 Sec.....Select this function allow you to unplug the AC power directly after the shutdown, without waiting for the projector cooling off.

NOTE:

- When set the option 0 Sec, user cannot restart the projector immediately after turning off it.
- While sometimes, the lamp may take a longer time to cool off than usual to light again for high temperature.

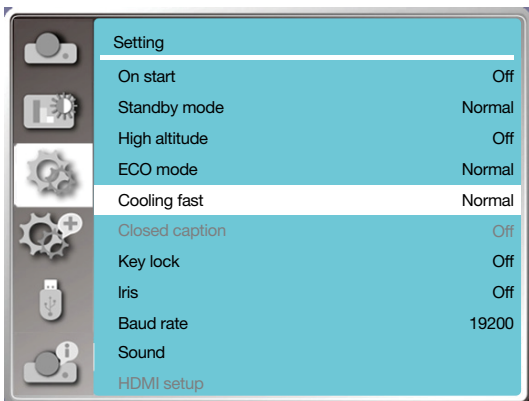

[Closed caption]

Closed Caption is used for displaying the program sound or other information on the screen. select this function to switch channel with input signal of closed caption.

- 1) Press ▲▼ button to select [Closed caption] menu.
- 2) Press <ENTER> button.
- 3) Press ▲▼ button to switch required menu.

Off :No closed caption.

CC1.....Display CC1 data.

CC2.....Display CC2 data.

CC3.....Display CC3 data.

CC4.....Display CC4 data.

NOTE:

- The icon display gray if the Closed caption function is invalid.
- The Closed caption function is invalid when the OSD menu and Timer display on the screen.

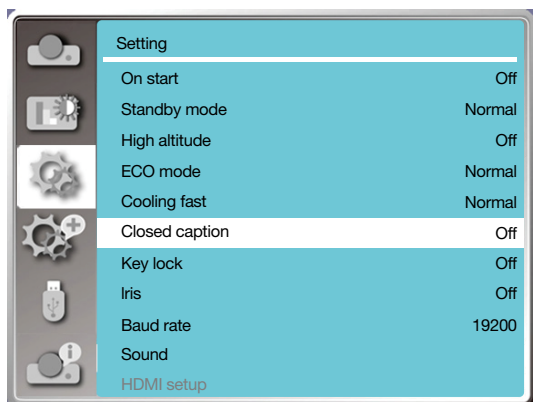

[Key lock]

Select this function to lock and unlock the control panel or remote controller keypad.

- 1) Press ▲▼ button to select [Key lock] menu.
- 2) Press <ENTER> button.
- 3) Press ▲▼ button to switch required menu.

Off.....The control panel or remote controller keypad are effective.

On.....The control panel keypad is invalid.

NOTE:

- If you lock the top of the control panel, but without a remote controller or something wrong with the remote controller, please contact your dealer or service center.

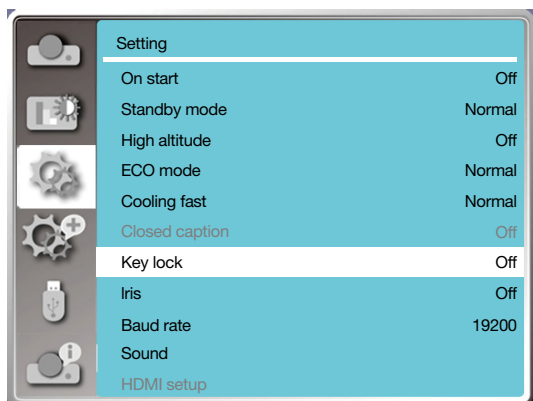

[Iris]

Adjust the light output to the image signal and perform projection with emphasis on contrast.

- 1) Press ▲▼ button to select [Iris] menu.
 - 2) Press <ENTER> button.
 - 3) Press ▲▼ button to adjust levels.
- Off.....No correction.
On.....Correct iris.

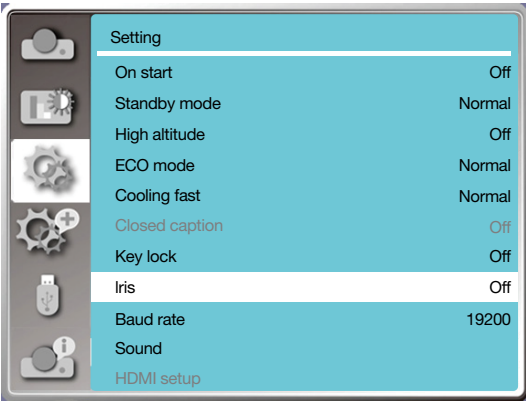

[Baud rate]

Select this function to adjust the projector transmission rate.

- 1) Press ▲▼ button to select [Baud rate] menu.
- 2) Press <ENTER> button.
- 3) Press ▲▼ button to select rate: 19200/4800/38400/9600.

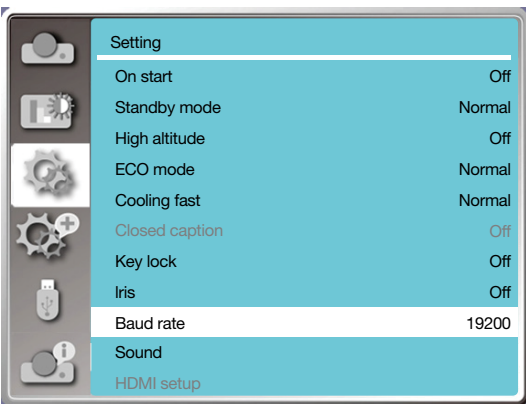

[Sound]

Select this function to adjust the sound.

- 1) Press ▲▼ button to select [Sound] menu.
- 2) Press <ENTER> button.
- 3) Press ▲▼ button to switch required menu.

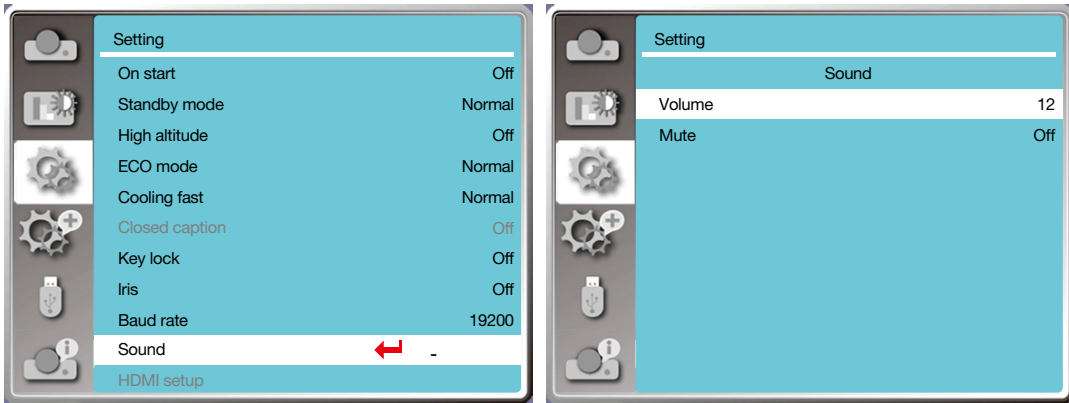

[HDMI setup]

When the external device is connected to the HDMI terminal of the projector, and the images can not be projected normally, please switch on the image or sound setting.

Press < MENU > button on the remote controller or on the top control panel to display the OSD menu. Press ▲▼ button to select the setting menu ,then press <ENTER> or ► button to enter the sub-menu.

- 1) Press ▲▼ button to select [HDMI setup] menu.
- 2) Press <ENTER> button.
 - Display [HDMI setup] instantly.
- 3) Press ▲▼ button to select [Image] / [Sound] / [HDMI EQ setup].
- 4) Press <ENTER> button.

NOTE:

- HDMI setup option can be chosen only in HDMI 1 and HDMI 2 channel.

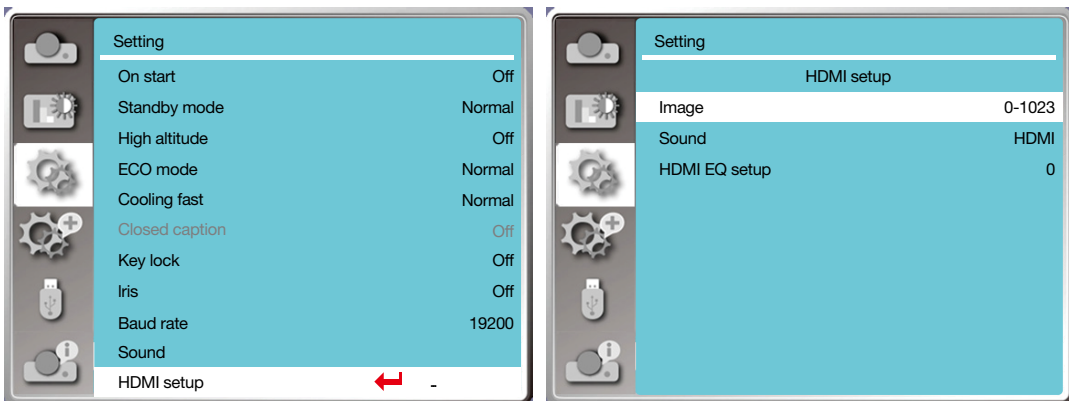

Image

Auto	Set the signal level automatically.
[64-940]	When external device (such as a Blu-ray disc player) is connected to the HDMI setup terminal.
[0-1023]	When the output of an external device (such as a computer), via a conversion cable or a similar cable, is connected to the HDMI setup terminal. Select this option when the output of the PC or any other device is connected to the HDMI setup terminal also.

Sound

[HDMI]	When connect to the HDMI cable to transmit images and audio while the users do not need connect to audio signal separately.
[Computer]	When the output of an external device (such as a computer), via a conversion cable or a similar cable, is connected to the HDMI terminal. The audio signal would be output according to the connection of AUDIO IN terminal.

HDMI EQ setup

Mode 0-3	Change the HDMI reception level according to the AV device connected to the HDMI input terminal. If noise appears in the image or the image does not appear, change the settings.
----------	--

7 Menu Descriptions & Functions [Expand]

The projector has expand function, you can select other functions as described below.

Menu operation

Press < MENU > button on the remote controller or on the top control panel to display the OSD menu. Press ▲ ▼ button to select the Expand menu, then press <ENTER> or ► button.

- 1) Press ▲ ▼ button to select required item.
- 2) Press <ENTER> button.
- 3) Press ▲ ▼ button to set options.
- 4) Press <ENTER> button.

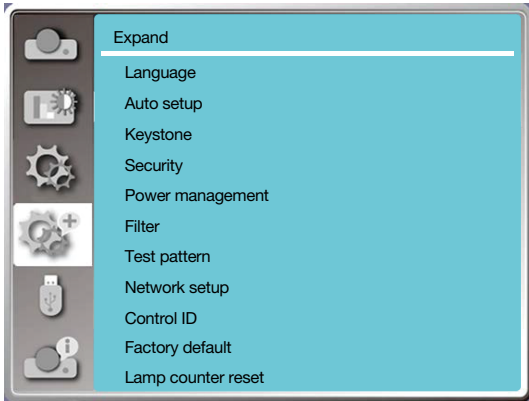

[Language]

Users can selected the language displayed on the screen.

- 1) Press ▲ ▼ button to select [language] menu.
- 2) Press <ENTER> button.
- 3) Press ▲ ▼ button to select required language.
- 4) Press <ENTER> button.

The name of menus, setting, the OSD, button etc., can displayed by the selected language.

Your projector comes with multiple language support. You may select required one from them, such as: English, German, French, Italian, Spanish, Polish, Swedish, Dutch, Portuguese, Japanese, Simplified Chinese, traditional Chinese, Korean, Russian, Arabic, Turkey, Finland, Norway, Denmark, Indonesia, Hungary, Czech Republic, Kazakhstan, Vietnamese, Thai, Farsi, Romania.

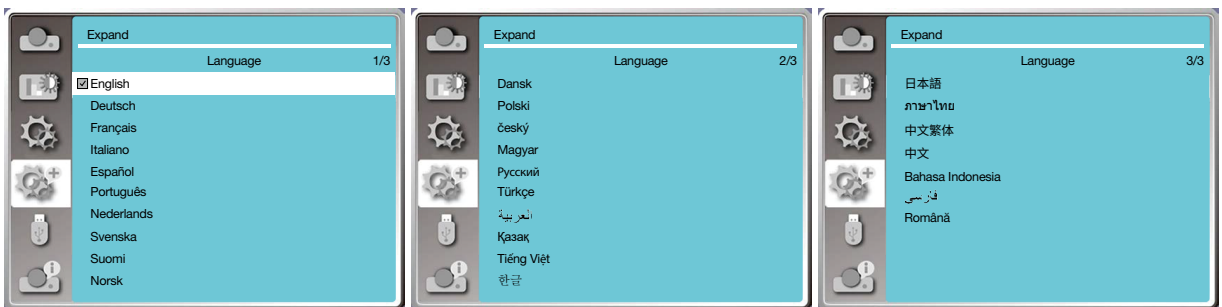

[Auto setup]

Select this function to store or reset the keystone or some related setting after unplugging the AC power.

Press < MENU > button on the remote controller or on the top control panel to display the OSD menu. Press ▲ ▼

Press the AUTO button on your remote controller to execute the following functions : Input search, Auto PC adj. , and Auto keystone.

1) Press ▲ ▼ button to select [Auto setup] menu.

2) Press <ENTER> button.

3) Press ▲ ▼ button to select required items.

Input search: Select this function to detect the signal, then project images automatically.

Auto PC adj.: Select this function to adjust [Fine sync], [H Position], [V Position] and [H. size] automatically, when projector input analog signals.

Auto keystone: select this function to correct vertical distortion of the projected image automatically.

NOTE:

- One of input search, Auto PC adj. and Auto keystone option should be set to On at least .
- Please adjust the projector manually, if the image is displayed abnormal even if you have select Auto keystone function.
- When you set Project way as Ceiling / Front or Ceiling / Rear, Auto keystone function is invalid.
- When you set Project way as Auto ceiling / Front or Auto ceiling / Rear, and users put their projector in ceiling state, the Auto keystone function will be invalid.
- When select auto search for input source search, USB-A and LAN signals are not in the scope of auto search function.

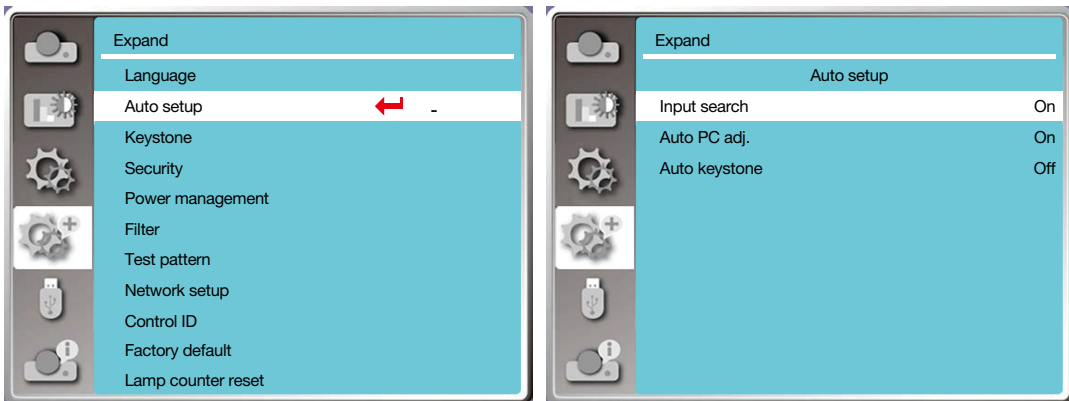

[Keystone]

Select this function to store or reset the keystone or some related setting after unplugging the AC power.

Press < MENU > button on the remote controller or on the top control panel to display the OSD menu. Press ▲ ▼ button to select the expand menu, then press <ENTER> or ► button to enter.

1) Press ▲ ▼ button to select [keystone] menu.

2) Press <ENTER> button.

3) Press ▲ ▼ button to select required item.

4) Press <ENTER> button.

Keystone

Select this function to store and reset keystone after closing the projector or unplugging the AC power .

Store.....store keystone after closing the projector or unplugging the AC power cord .

Reset.....keystone function will be cancelled after closing the projector or unplugging the AC power.

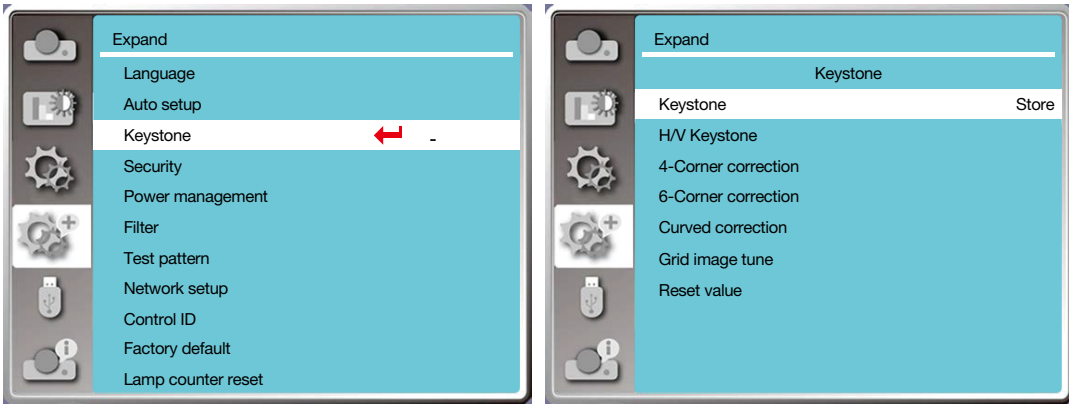

Keystone

Select this function to correct the projected images horizontally or vertically.

Press ▲ button to reduce upper width

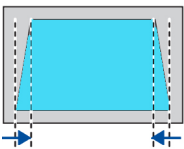

Press ▼ button to reduce bottom width

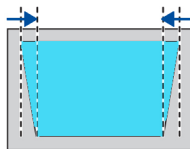

Press ◀ button to reduce left width

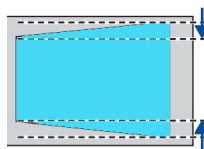

Press ▶ button to reduce right width

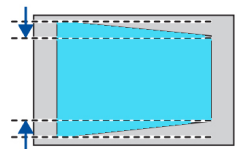

4-Conner correction

Select this function to correct the projected images of four corners distorted.

Press ▲▼◀▶ button to keystone at four corners of the screen. The four corners are looped in sequence shown below:

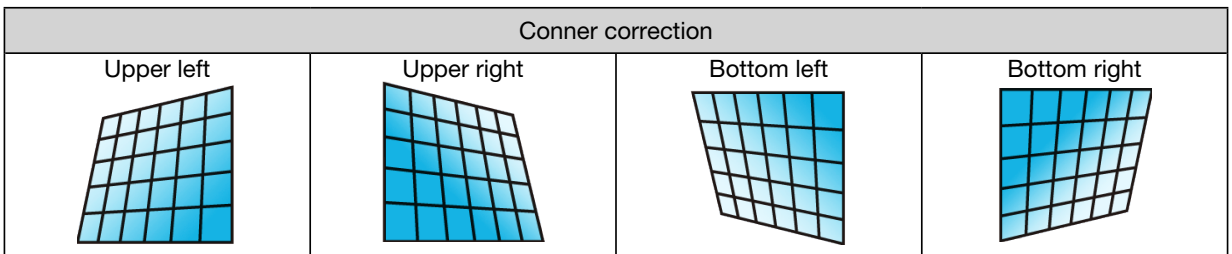

6-Conner correction

Select this function to correct the projected images of six corners distorted.

Press ▲▼◀▶ button to keystone at six corners of the screen. The six corners are looped in sequence shown below:

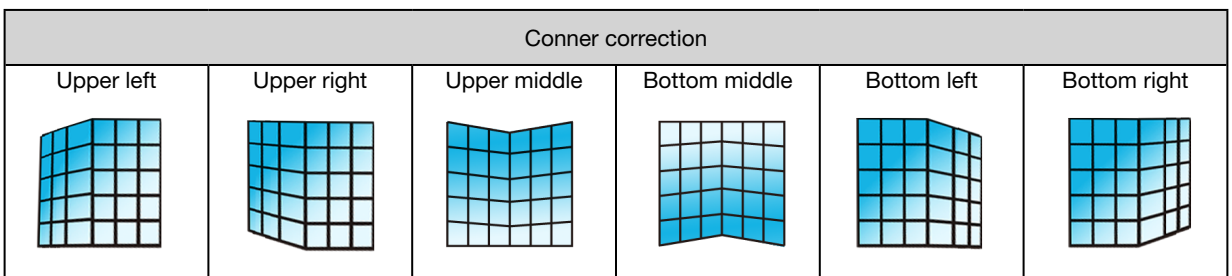

Curved correction

Select this function to correct the projected images with linearity uneven or vertical and horizontal bending deformation. press ▲▼◀▶ button to adjust options.

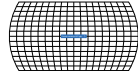
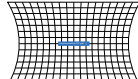
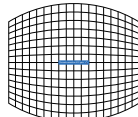
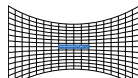
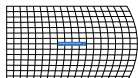
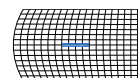
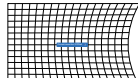
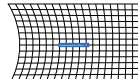
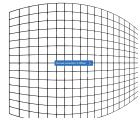
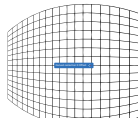
Item	Operation	Adjustment	
Curved correction X/Y gain	Press ▶	Extend left and right vertically	
	Press ◀	Sag left and right vertically	
	Press ▲	Reach up and down horizontally	
	Press ▼	Sag up and down horizontally	
Curved correction X offset	Press ◀	Correct the vertical lines on the left. Expand the top and bottom while maintaining the central area	
	Press ▶	Correct the vertical lines on the right. Expand the top and bottom while maintaining the central area	
	Press ◀	Correct the horizontal line on the left. Expand the top and bottom while maintaining the central area.	
	Press ▶	Correct the horizontal line on the right. Expand the top and bottom while maintaining the central area.	
	Press ◀	Correct the horizontal line on the left. Expand the top and bottom while maintaining the central area.	
	Press ▶	Correct the horizontal line to the right. Expand the top and bottom while maintaining the central area.	

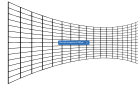
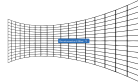
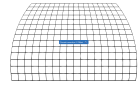
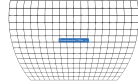
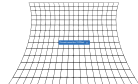
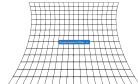
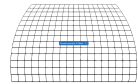
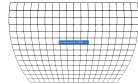
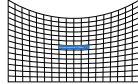
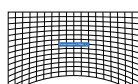
Item	Operation	Adjustment	
Curved correction X offset	Press ◀	Correct the horizontal line on the left. Expand the top and bottom while maintaining the central area.	
	Press ▶	Correct the horizontal line to the right. Expand the top and bottom while maintaining the central area.	
Curved correction Y offset	Press ▼	Correct vertical lines on both sides. Expand the lower corners while maintaining the central and upper regions	
	Press ▲	Correct vertical lines on both sides. Expand the top corners while maintaining the central and upper regions	
	Press ▼	Correct vertical lines on both sides. Expand the lower corners while maintaining the central and upper regions	
	Press ▼	Correct vertical lines on both sides. Expand the lower corners while maintaining the central and upper regions	
	Press ▼	Correct vertical lines on both sides. Expand the lower corners while maintaining the central and upper regions	
	Press ▲	Correct vertical lines on both sides. Expand the top corners while maintaining the central and upper regions	
	Press ▼	Correct vertical lines on both sides. Expand the lower corners while maintaining the central and upper regions.	
	Press ▲	Correct vertical lines on both sides. Expand the upper corner while keeping the central and lower regions unchanged.	

NOTE:

- After adjusting values about h/v keystone , if users adjust conner correction, values about h/v keystone will be reset . and after adjusting values about conner correction, if users adjust about h/v keystone, values about conner correction will be reset also.
 - Curved correction X offset and curved correction y offset can not be adjusted individually. Adjust curved correction X offset and curved correction y offset after adjusting the x/y curved correction.
 - Maximum keystone range up to $\pm 30^\circ$ vertically and $\pm 30^\circ$ horizontally. However, the image quality will deteriorate, and becoe more difficult to focus. install the projector with the minimal correction value.
 - The screen size will be changed with various h/v keystone adjustments .
 - Keystone may influence image aspect .
-

Grid image tune

select this function to adjust the local points of the projected image.

- 1) Press ▲▼◀▶ button to select [Grid image tune] option.
- 2) Press <ENTER> button.

Reset

Select this function to make adjustment value back to the factory default.

- 1) Press ▲▼◀▶ button to select [Reset] option.
- 2) Press <ENTER> button.
 - Release keystone mode.

[Security]

Set a passcode to lock the usage of the projector to prevent unauthorized personnel from operating your projector. Once the projector is on, the [passcode] screen will be displayed.

- 1) Press ▲▼ button to select [Security] menu.
- 2) Press <ENTER> button.
- 3) Press ▲▼ button to switch required item.

PIN code lock

This function helps preventing unauthorized personnel from changing projector setting.

Off.....PIN code lock function is not available.

On.....The [PIN code] screen will appear when the projector is on. If you want to change the PIN code lock or password (for three digits), you must enter the password. The factory default password is "111."

PIN code change

- You can change the Passcode. Click the [ENTER] button and select [Change Passcode]. When the [Passcode] dialog box is displayed, press the ◀▶ button to enter a valid Passcode, and select [Set] to display the [New Passcode] dialog box. Set a new Passcode, confirm the contents in the dialog box, and select Set to set a new Passcode.
- The number you typed is displayed as " * ". To edit number you have entered, press menu button to move the cursor to the number you want to change, press ◀▶ button to select the correct one.
- Repeat this step to type in a 3-digit number.
- Enter a three-digit number, move the cursor to "set" . Press the ENTER button, you can start to operate the projector.
- If the Passcode is invalid, the Passcode displayed as " *** " will be in red. Please try again with a valid one.
- Please remember your new password and keep it safe.

To cancel the passcode

- (1) While simultaneously pressing the [POWER] button and [ENTER] button on the main unit, plug the power cord into the main unit. After a while keep pressing the button, the passcode input screen appears. Enter "111".
- (2) Select OSD menu Security >> PIN code lock >> "On". As the input screen appears again, enter the default value (111) and set the passcode to "off" or set a new passcode.

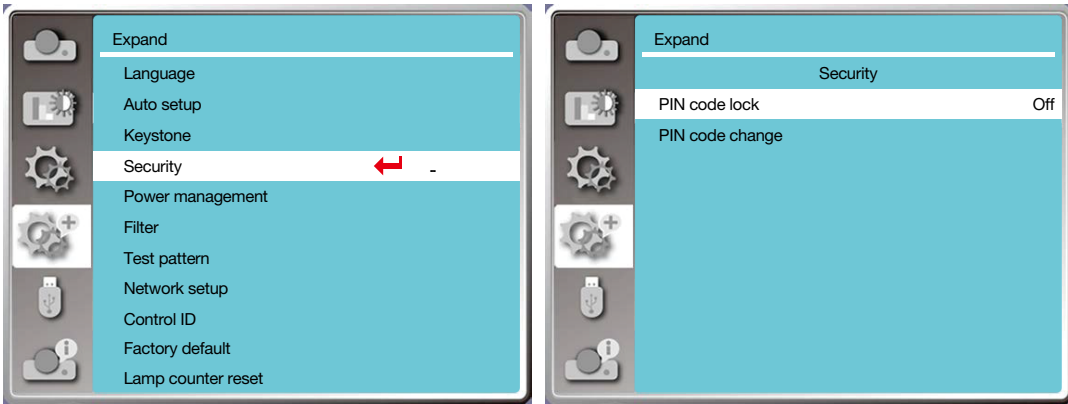

[Power management]

To reduce power consumption and maintain life cycle of light source, the power management function will turn off the projection light source if your projector has no signals for a period of time.

- 1) Press ▲▼ button to select [Power management] menu.
- 2) Press <ENTER > button.
- 3) Press ▲▼ button to switch required item.

Ready.....the power light indicator flashes green when the lamp is fully cooled down. The light source turns on again if an input signal is connected or any key (except the power button) on the side panel and remote controller is pressed during this period of time.

Shut down.....The projector shut down after the light source is fully cooled down.

Off.....Disable the power management function.

Timer.....Once the input signal is interrupted and no keys has been pressed for 30 seconds afterwards, the “No signal” message displays in the timer. The timer counts down until the light source turns off. Press arrow key to set up the timer in range of 1~30 minutes.

Ready countdown.....Set the interval from ready mode change to standby mode (0 to 30 minutes) automatically. When it is set it to zero, the projector will never change automatically. Press the Power key to change your projector into standby mode and any other key to power on.

NOTE:

- Factory default for standby time: 5 minutes. Count down for ready mode: 5 minutes.
- When selecting [Off], the [Timer] and [Ready countdown] is unavailable.
- When selecting [Shut down], the [Timer] is unavailable.

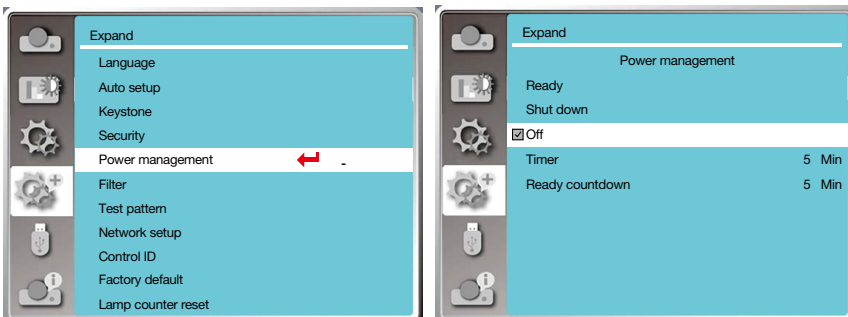

Remaining time before poweroff the light source.

[Filter]

Set this function to reset the filter usage time and set up warning display.

- 1) Press ▲▼ button to select [Filter] menu.
- 2) Press <ENTER> button.
- 3) Press ▲▼ button to switch required item.

When the projector reaches the user-set cleaning time, filter warning icon will appear on the screen to notify the user needs to clean the projector filter. please make sure to select the initial state and set the timer after cleaning it. once resetting filter counter, filter warning icon will be closed.

Filter counter.....Displays the filter usage time.

Timer.....Set the time to display a warning icon.

Filter counter reset.....Reset filter counter.

Filter clogging check.....Check the temperature inside the projector and make reactions.

On: Check filter.

- Once the projector has checked any filter problem, the screen will display a warning icon "Filter warning! please change the filter! ".

Off: DO NOT check filter.

NOTE:

- The screen will display the icon "Filter warning! please change the filter! " when the projector has checks one warning. And the the warning icon will disappear 30S later atuomatically, while only the power button is effective during that period.the projector will give warning again if the projector has checked filter block and will record the information.

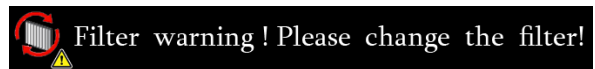
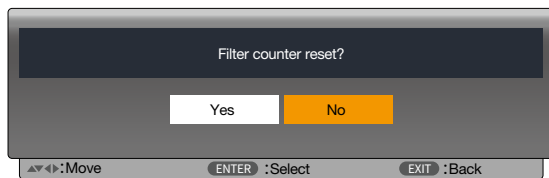
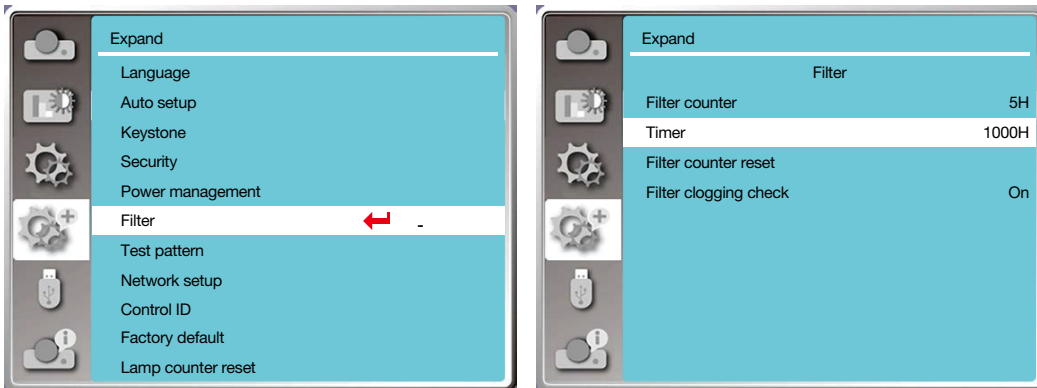

[Test pattern]

Select this function to display the projector's built-in test pattern.

- 1) Press ▲▼ button to select [Test pattern] menu.
- 2) Press <ENTER> button.
- 3) Press ▲▼ button to switch required item.
- 4) Press <ENTER> button.

Off / Gray scale 1 / Gray scale 2 / Gray scale 3 / Gray scale 4 / Color bar / Red / Green / Blue / Cross hatch / White / Black / Raster gray: Use The OSD menu to display the test pattern.

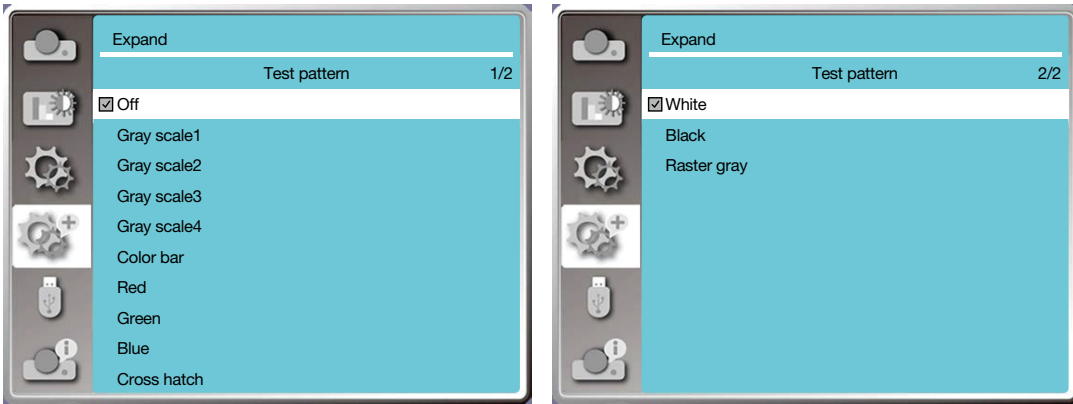

[Network setup]

Function: This function is designed to allow the computer control the projector remotely via intranet.

1.Required equipment: Projector, computer, network cable

2.Connection:

Connect your projector to a router or switch in the LAN with normal or jumper network cable. In case a normal network cable failed to connect successfully, use a jumper cable instead.

3.Turn on the computer. The LAN port on computer and projector are flashing after power on the projector.

Operation steps

1. Power on your projector.

2. Acquire the IP address, with DHCP set to on and auto IP allocation set to On. (You may set DHCP to Off and set up IP address manually if you are somehow familiar with networking.)

3. Enter the network setup menu

(1) Press MENU button on remote controller or top of the control panel, press ▲▼ button to select LAN icon.

(2) Press ▲▼ button select network settings and press ENTER button to enter.

MAC address.....Display the MAC address of wired network.

IP address.....Display the ip address of wired network.

(3) Press ▲▼ button to set DHCP On to obtain an IP address, subnet , gateway and DNS automatically , and press ENTER button to confirm.

Press ▲▼ button to set DHCP off, then press ENTER button to enter an IP address, then press ▼ button to select subnet , gateway and dns automatically.and press ENTER button to confirm.

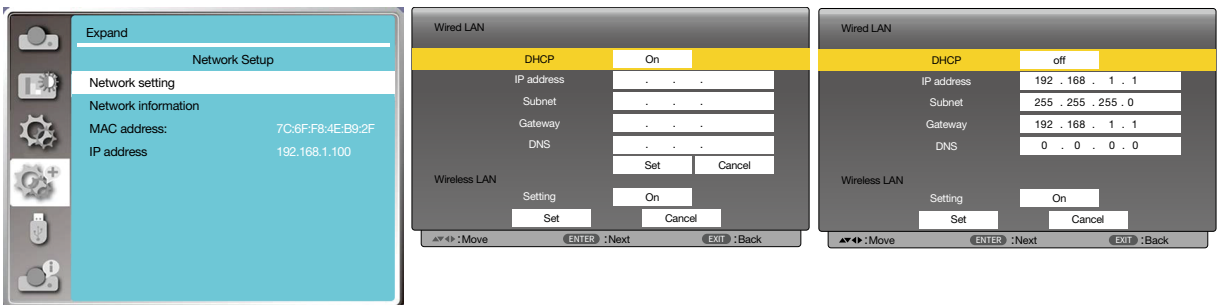

[Control ID]

1. Turn on the projector.
2. Press the ID SET button on the remote control.

The CONTROL ID screen will be displayed.

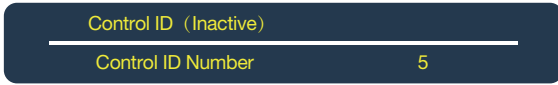

If the projector can be operated with the current remote control ID, the [ACTIVE] will be displayed. If the projector cannot be operated with the current remote control ID, the [INACTIVE] will be displayed. To operate the inactive projector, assign the control ID used for the projector by using the following procedure (Step 3).

3. Press one of numeric keypad buttons while pressing and holding the ID SET button on the remote control.

Example:

To assign “3”, press the “3” button on the remote control.

No ID means that all the projectors can be operated together with a single remote control. To set “No ID”, enter “000” or press the CLEAR button.

TIP: The range of IDs is from 1 to 254.

4. Release the ID SET button.

The updated Control ID screen will be displayed.

NOTE:

- The IDs can be cleared in a few days after the batteries are run down or removed.
- Accidentally pressing any one of the buttons of the remote control will clear currently specified ID with batteries removed.

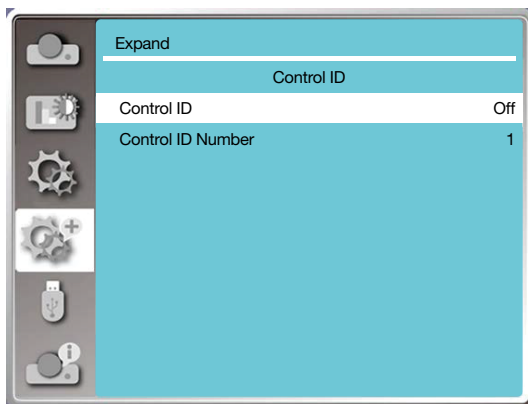
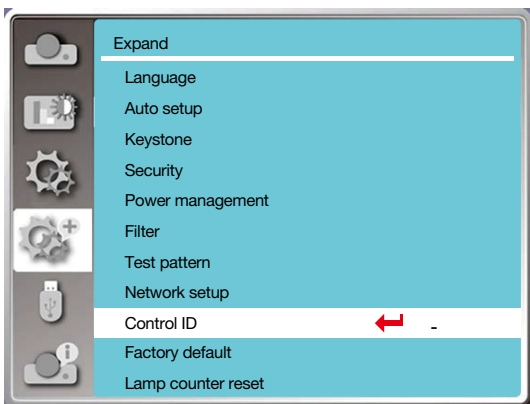

[Factory default]

This function resets all your settings to factory default.

- 1) Press ▲▼ button to select [Factory default] menu.
- 2) Press <ENTER or ► > button.
- 3) Press ◀▶ button to select yes ,then press <ENTER> button.

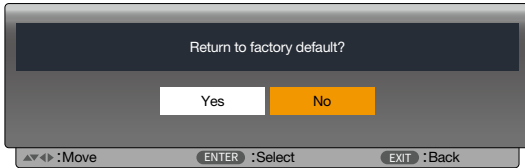

[Lamp counter reset]

Make sure to reset the lamp counter, when replacing the lamp. Then the warning indicator goes out and the lamp replacement icon will disappears.

- 1) Press ▲▼ button to select [Lamp counter reset] menu.
- 2) Press <ENTER or ► > button.
- 3) Press ◀▶ button to select yes ,then press <ENTER> button.

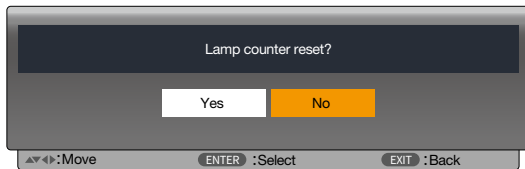

8 Menu Descriptions & Functions [USB-A]

The projector has expand fuction, you can select other functions as described below.

When the USB memory inset into the projector, the viewer memory function can project the video and pictures stored in the USB memory.

Press < MENU > button on the remote controller to display the OSD menu. Press ▲▼ button to select the USB-A menu ,then press <ENTER> or ► button.

- 1) Press ▲▼ button to select required item.
- 2) Press <ENTER> button.
- 3) Press ▲▼ button to set options.
- 4) Press <ENTER> button.

NOTE:

- When selecting [USB-A] as input signal, the "USB-A" menu is available.
- In addition to "Set slide" menu, even change the settings, If you do not implement the [Application], the setting value of the change is invalid.

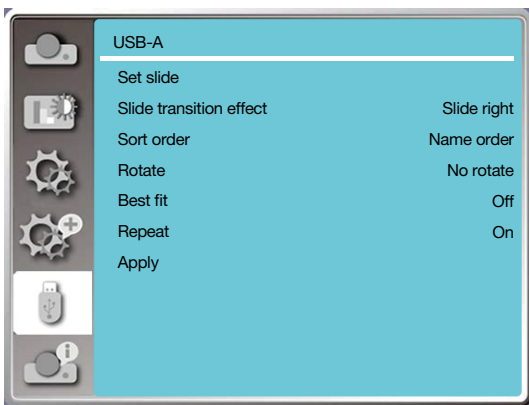

[Set slide]

Select this function to play slides.

- 1) Press ◀▶ button to select a file.
- 2) Press ▲▼ button to select [Set slide] menu.
- 3) Press <ENTER> or ►> button.
 - Full screen display
 - Press <ENTER> to return the thumbnail.

[Slide transition effect]

Select this function to set the slide's playback, when switching slides.

- 1) Press ▲▼ button to select [Slide transition effect] menu.
- 2) Press <ENTER> or ►> button.
- 3) Press ▲▼ button to switch required item.

Slide down.....Switch slides from the upper to the lower .

Slide right..... Switch slides from left to the right.

[Sort order]

Select this function to set the slide's order.

- 1) Press ▲▼ button to select [Sort order] menu.
 - 2) Press < ENTER > button.
 - 3) Press ▲▼ button to switch required item.
- Extend order..... Sort by extend names of file or folder.
Size order..... Sort by size of file or folder.
Time order..... Sort by the time of file or folder.
Name order..... Sort by names of file or folder.

[Rotate]

Set the rotation direction of images.

- 1) Press ▲▼ button to select [rotate] menu.
 - 2) Press < ENTER > button.
 - 3) Press ▲▼ button to switch required item.
- No rotateRotation is invalid.
270 degree.....Rotate counterclockwise by 270 degrees.
180 degree.....Rotate clockwise by 180 degrees.
90 degree..... rotate clockwise by 90 degrees.

[Best fit]

Set the image to be compatible with projection screen.

- 1) Press ▲▼ button to select [Best fit] menu.
 - 2) Press < ENTER > button.
 - 3) Press ▲▼ button to switch required item.
- On.....Display images by the aspect ratio of the screen.
Off.....Display image by the normal pixels.

[Repeat]

Select this function to play slides repeatedly.

- 1) Press ▲▼ button to select [repeat] menu.
 - 2) press <ENTER or ►> button.
 - 3) Press ▲▼ button to switch required item.
- On.....Replay the first document,after playing the last one.
Off.....return to the thumbnail display screen,after playing the last one.

[Apply]

Only be used in playing slides.

- 1) Press ▲▼ button to select [Apply] menu.
- 2) press <ENTER or ►> button.

9 Menu Descriptions & Functions [Info.]

Select info. function to detect the projected image signal and the projector operating status.

Press <HELP > button on the remote controller or <MENU> button on the control panel to display the OSD menu. Press ▲▼ button to select the info. menu, then press <ENTER> or ► button.

Info. display as follows:

Input.....Display selected input source.

H- sync freq.....Display H- sync freq. of input signal in unit of KHz. Show “---KHz” when no signals are in existence.

V- sync freq.....Display V- sync freq. of input signal in unit of KHz. Show “---KHz” when no signals are in existence.

Lamp counter.....Display the lamp's usage time.

Model name.....Display the projector's model name.

S/N.....Display the projector's serial number.

Firmware version.....Display the projector's firmware version.

SUBCPU.....Display the projector's SUBCPU.

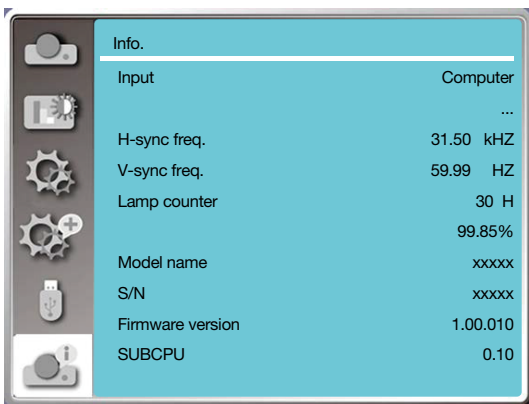

6. Network control

1 Network control operation

Function: This function is designed to remote control computer in the same LAN.

Preparation

1. Required equipment: Projector, Computer, Network cable

2. Connection:

Connect your projector to a router or switch in the LAN with normal or jumper network cable. In case a normal network cable failed to connect successfully, use a jumper cable instead.

3. Turn on the computer. The LAN port on computer and projector are flashing after power on the projector.

Operation steps

1. Power on your projector.

2. Acquire the IP address, with DHCP set to on and auto IP allocation set to On. (You may set DHCP to Off and set up IP address manually if you are somehow familiar with networking.)

3. Enter the network setup menu

(1) Press MENU button on remote controller or top control panel, press ▲▼ button to select LAN icon.

(2) Press ENTER button or ► button and the network menu displays.

(3) Press ▲▼ button select network settings and press ENTER to confirm.

(4) Press ▲▼ button to set DHCP On and press ENTER button to confirm.

(5) Press ▲▼ button to select Set, press ENTER button to wait until the “Please wait..” message disappears.

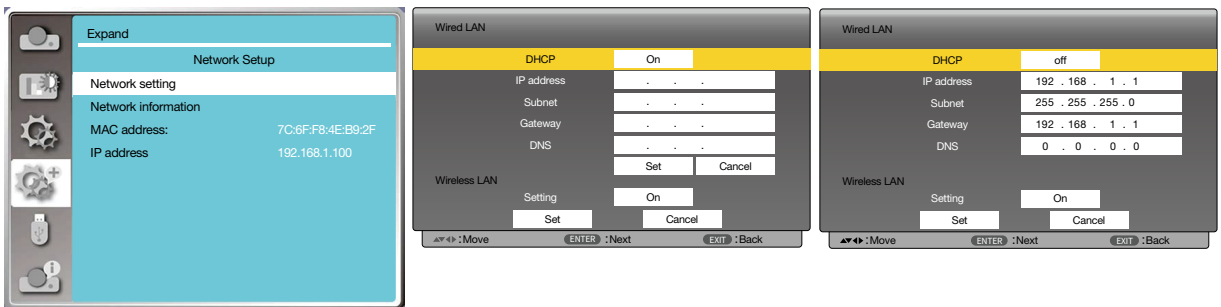

NOTE:

- If you are using the wireless LAN connection, please check the SSID / ESSID and wireless IP address in the network setting status , and write down the information.

② Enter through a Web browser

Connecting Your Computer

- 1) Start the computer's Web browser.
- 2) Enter the IP address on the projector set in the URL input field of the Web browser.
- 3) Enter the password in the [Password], then click [Login].
 ** "the factory default setting is the user name: "admin" (administrator privileges), password: "admin".

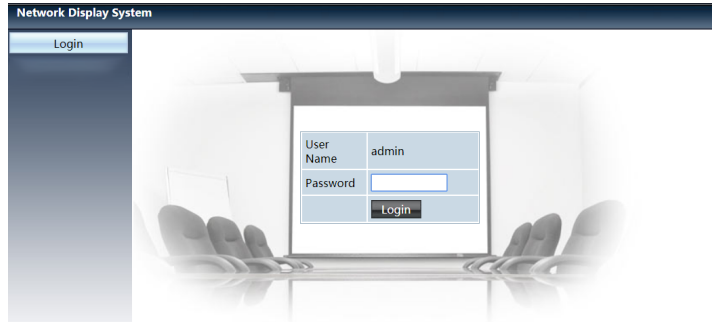

- 4) Click the [Login]

NOTE:

- Users can click on the top right corner of the Web browser screen to select the display language.
- Do not start multiple Web browser settings or control. Do not use more than one computer set or control the projector.
- Please change your password.
- If the network does not appear on screen controls, please consult your network administrator.
- Please refresh the web page before operating the main body.

Description of each option

Network Display System > System Status	
①	System Status
②	General Setup
③	Picture Setup
④	Image Setup
⑤	Network Setup
Model Name NP-ME403U	
Versions	
Firmware Version	1.00.010
LAN Status	
IP Address	192.168.3.19
Subnet	255.255.255.0
Gateway	192.168.3.1
Wire MAC Address	00:20:00:20:00:20

- ① System status: Click this option to display the [System status] page.
- ② General setup: Click this option to display the [General setup] page.
- ③ Picture setup: Click this option to display the [picture setup] page.

- ④ Image setup: Click this option to display the [image setup] page.
- ⑤ Network setup: Click this option to display [Network setup] page.

③ [System status] page

Network Display System > System Status

System Status	Model Name	NP-ME403U
General Setup	Versions	
Picture Setup	Firmware Version	1.00.010
Image Setup	LAN Status	
Network Setup	IP Address	192.168.3.19
	Subnet	255.255.255.0
	Gateway	192.168.3.1
	Wire MAC Address	00:20:00:20:00:20

- ① Versions: Displays the firmware version of the projector.
- ② LAN status: Displays the LAN. connection status.

④ [General setup] page

Network Display System > General Setup

System Status	Change Password for Webpage	
General Setup	Enter Old password	<input type="text"/>
Picture Setup	Enter New password	<input type="text"/>
Image Setup	Confirm New password	<input type="text"/>
Network Setup		Apply
	Power & Source	
	Power	<input checked="" type="radio"/> On <input type="radio"/> Off
	Source Select	HDMI-2

- ① Enter old password: Enter the password for the configuration.
- ② Enter new password: Enter a new password.
- ③ Confirm new password: Re-enter the new password to confirm.
- ④ Power & source: Update settings.
- ⑤ Power: Switch on the power of the projector on / off.
- ⑥ Source select: Switch the input source of the projector.

⑤ [Picture setup] page

Network Display System > Picture Setup

System Status	Brightness (0 --- 63)	-	32
General Setup	Contrast (0 --- 63)	-	32
Picture Setup	Sharpness (0 --- 15)	-	0
Image Setup	Color Temperature		
Network Setup	Red (0 --- 63)	-	32
	Green (0 --- 63)	-	32
	Blue (0 --- 63)	-	32

- ① Brightness: Adjust the brightness of the projected image.
- ② Contrast: Adjust the contrast of the projected image.
- ③ Sharpness: Adjust the sharpness of the projected image.
- ④ Color Temperature: Adjust the color temperature of the projected image.

6 [Image setup] page

Network Display System > Image Setup

System Status	Aspect	Normal ▾	①
General Setup	Fine sync (0 --- 31)	- 0 +	②
Picture Setup	H Position	- 0 +	③
Image Setup	V Position	- 0 +	④
Network Setup	H.Size (-15 --- 15)	- 0 +	⑤
	Freeze	<input type="radio"/> On <input checked="" type="radio"/> Off	⑥
	Auto PC adj.	<input type="checkbox"/>	⑦
	V Keystone (-60 --- 60)	- 0 +	⑧
	H Keystone (-60 --- 60)	- 0 +	⑨
	Corner correction TopLeft_x (0 --- 1279)	- 0 +	⑩
	Corner correction TopLeft_y (0 --- 799)	- 0 +	
	Corner correction TopRight_x (0 --- 1279)	- 1279 +	
	Corner correction TopRight_y (0 --- 799)	- 0 +	
	Corner correction BottomLeft_x (0 --- 1279)	- 0 +	
	Corner correction BottomLeft_y (0 --- 799)	- 799 +	
	Corner correction BottomRight_x (0 --- 1279)	- 1279 +	
	Corner correction BottomRight_y (0 --- 799)	- 799 +	

- ① Aspect: Switch the aspect ratio of the projected image.
- ② Fine sync: Adjust the phase of the projected image.
- ③ H position: Adjust the horizontal position of the projected image.
- ④ V position: Adjust the vertical position of the projected image.
- ⑤ H. size: Adjust the horizontal dimension of the projected image.
- ⑥ Freeze: Select the function to switch the screen freeze on and off.
- ⑦ Auto PC adj.: Implement the automatic computer adjustment function.
- ⑧ V keystone: Correct trapezoidal distortion in vertical direction.
- ⑨ H keystone: Correct horizontal distortion in horizontal direction.
- ⑩ Corner correction: Correct four angles of the projected image.

7 [Network setup] page

Network Display System > Network Setup

System Status			Obtain an IP address automatically <input type="checkbox"/> Use the following IP address <input checked="" type="checkbox"/>
General Setup			
Picture Setup			
Image Setup			
Network Setup			
LAN Setup	IP Address	192 . 168 . 0 . 11	Apply
	Subnet	255 . 255 . 255 . 0	
	Gateway	192 . 168 . 0 . 1	
	DNS	192 . 168 . 0 . 1	
Creston Control	IP Address	192.168.0.2	Send
	IP ID	5	
	PORT	41794	
Wireless Setup	Wireless LAN	Enable <input type="checkbox"/> Disable <input checked="" type="checkbox"/>	Apply
	ESSID		
	AP/AdHoc Encryption	Disable	
	AP/AdHoc key		

① Network setup

If you want to enable the DHCP client, select the IP address automatically.

IP address:

Please enter the IP address when you do not use the DHCP server.

Subnet :

Please enter a subnet shield,when you do not use the DHCP server .

Gateway:

Please enter the gateway ,when you do not use the DHCP server.

DNS:

Please enter the DNS address, when you do not use the DHCP server.

Available characters : digital (0 - 9), a period (.)

(For example: 192.168.0.253)

② Apply

Update settings.

③ Crestron control

Connect Crestron tool by setting IP address, IP ID and Port options.

④ Wireless setup

Wireless LAN: Please select wireless LAN on or off.

ESSID: Please enter the ESSID.

AP/AdHoc Encryption: Please select password set on or off.

AP/AdHoc key: Please set password.

7. Installation and Connections

① Setting Up the Screen and the Projector

Use this to get a general idea of what the screen size will be when set in a certain position, what size screen you will need, and what distance you will need to project images of the desired size.

The projection distance range at which focusing is possible is 0.9 m (for 30 inches) to 10.9 m (for 300 inches). Install within this range.

[MC453X]

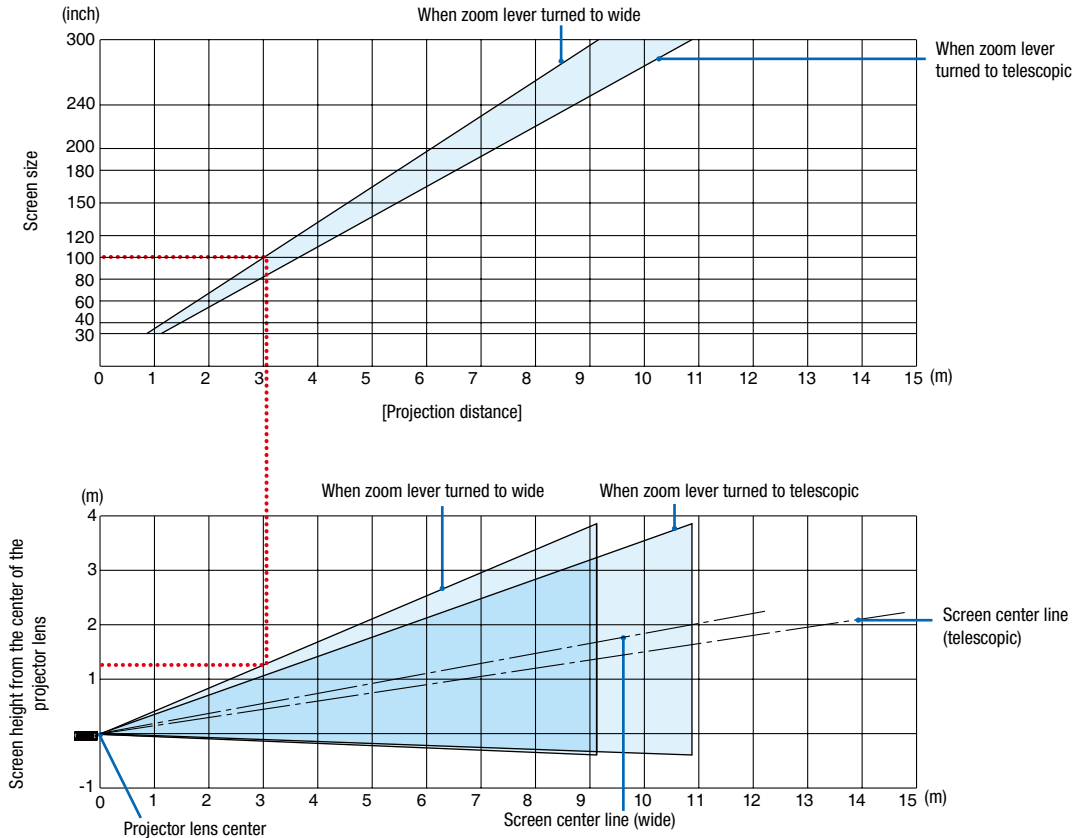

[Reading the Table]

From the upper table on this page, to project wide images on a 100 screen, install at about 3.0 m from the front. Also, from the lower table we can see that about 1.3 m are required from the projector's lens center to the upper edge of the screen. Use this to see whether or not enough height can be provided from the projector to the ceiling and for installing the screen. The diagram shows the projection distance when the projector is installed horizontally.

7. Installation and Connections

The projection distance range at which focusing is possible is 0.8 m (for 30 inches) to 13.8 m (for 300 inches). Install within this range.

[ME453X]

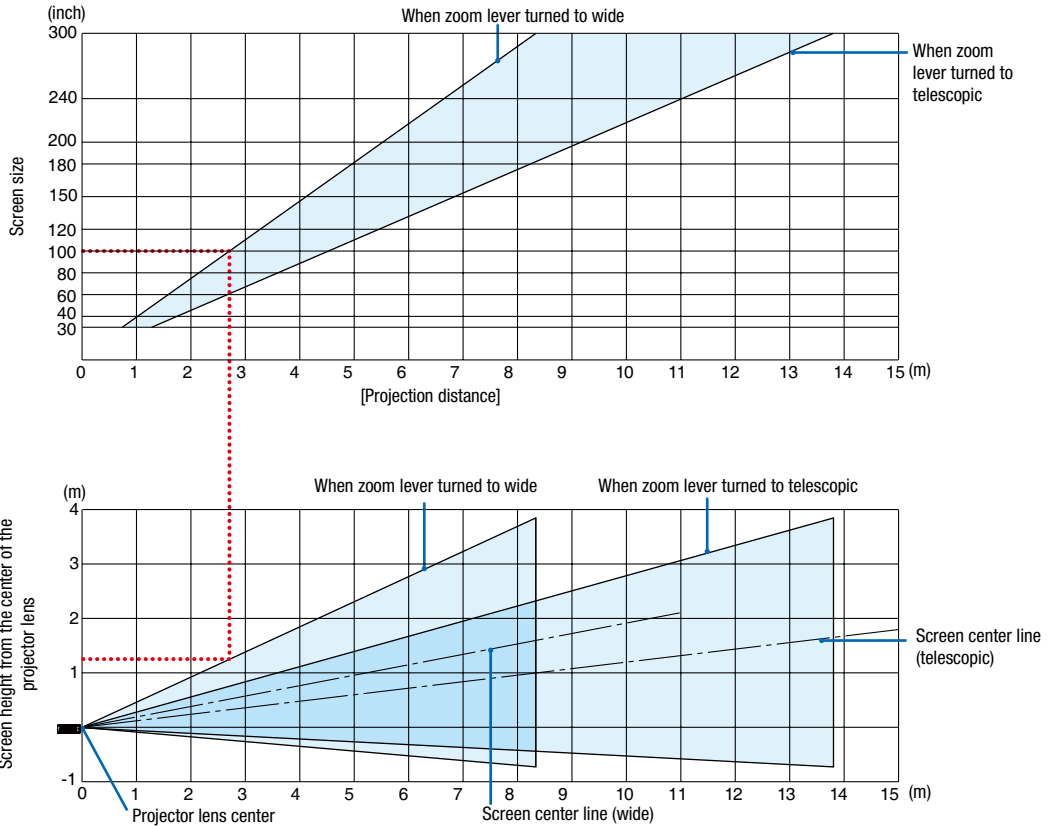

[Reading the Table]

From the upper table on this page, to project wide images on a 100 screen, install at about 2.7 m from the front. Also, from the lower table we can see that about 1.3 m are required from the projector's lens center to the upper edge of the screen. Use this to see whether or not enough height can be provided from the projector to the ceiling and for installing the screen.

7. Installation and Connections

The projection distance range at which focusing is possible is 0.8 m (for 30 inches) to 13.4 m (for 300 inches). Install within this range.

[ME423W/ME383W]

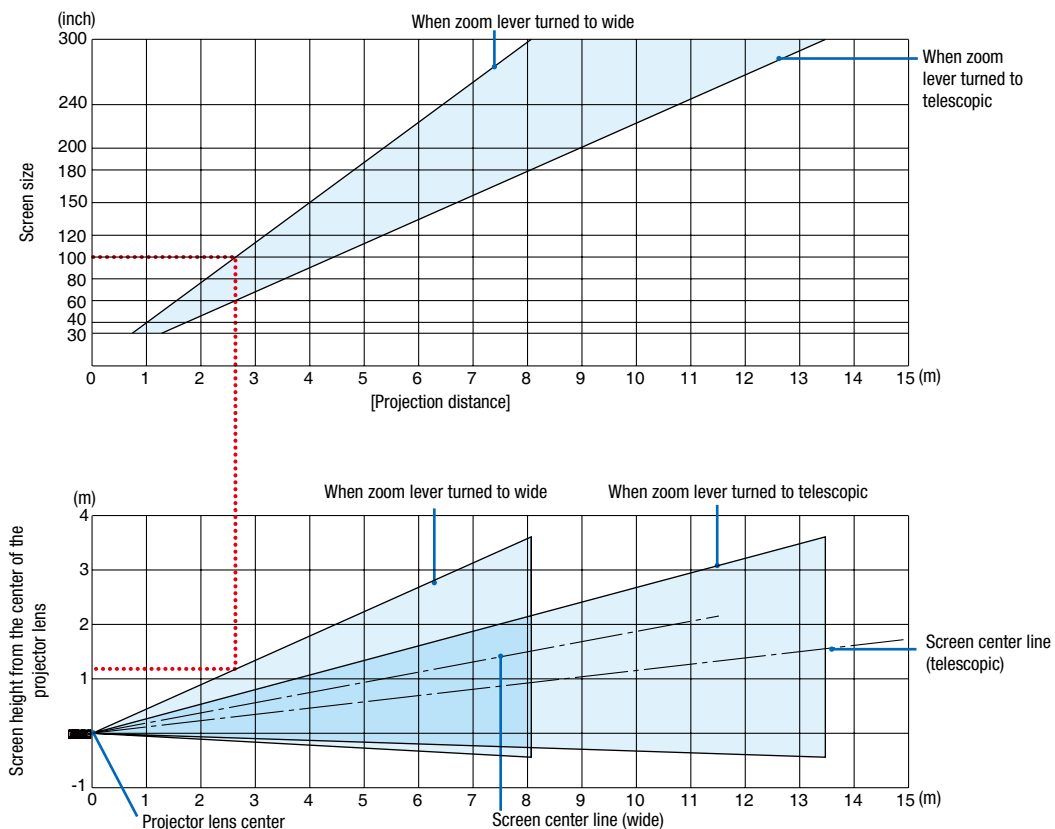

[Reading the Table]

From the upper table on this page, to project wide images on a 100 screen, install at about 2.7 m from the front. Also, from the lower table we can see that about 1.2 m are required from the projector's lens center to the upper edge of the screen. Use this to see whether or not enough height can be provided from the projector to the ceiling and for installing the screen.

7. Installation and Connections

The projection distance range at which focusing is possible is 1.0 m (for 30 inches) to 11.6 m (for 300 inches). Install within this range.

[MC393W]

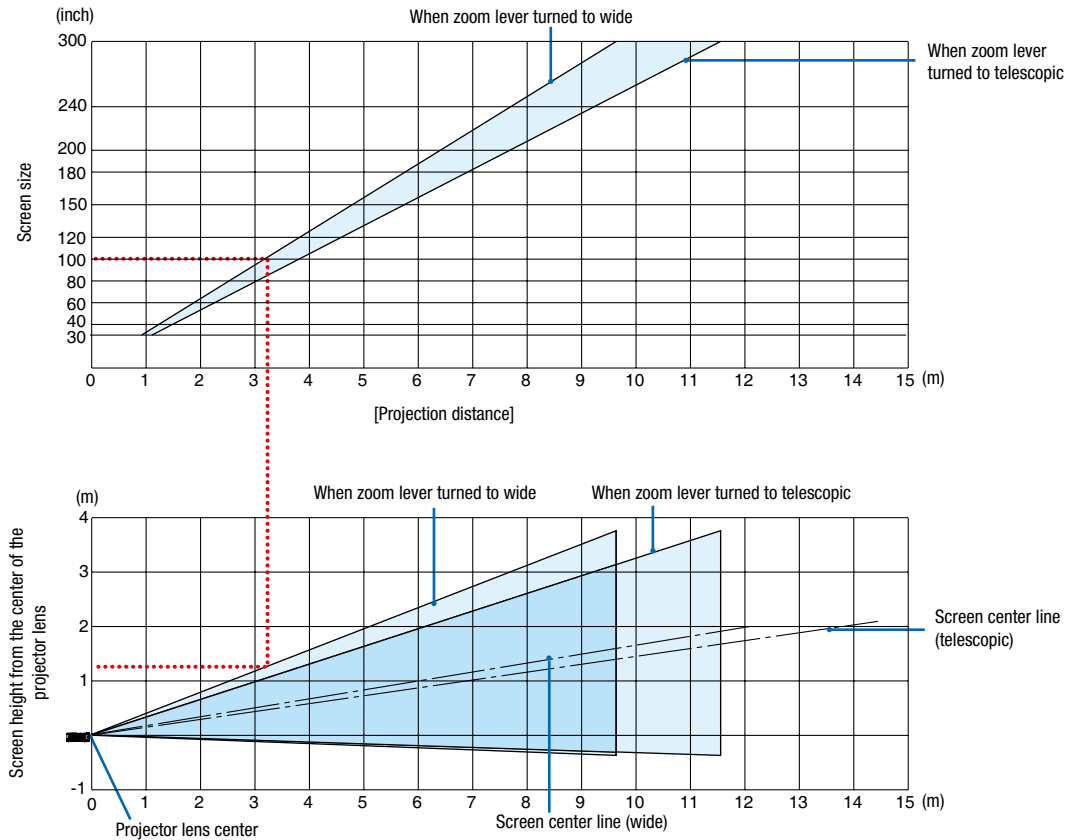

[Reading the Table]

From the upper table on this page, to project wide images on a 100 screen, install at about 3.2 m from the front. Also, from the lower table we can see that about 1.3 m are required from the projector's lens center to the upper edge of the screen. Use this to see whether or not enough height can be provided from the projector to the ceiling and for installing the screen. The diagram shows the projection distance when the projector is installed horizontally.

7. Installation and Connections

The projection distance range at which focusing is possible is 0.9 m (for 30 inches) to 10.7 m (for 300 inches). Install within this range.

[MC423W]

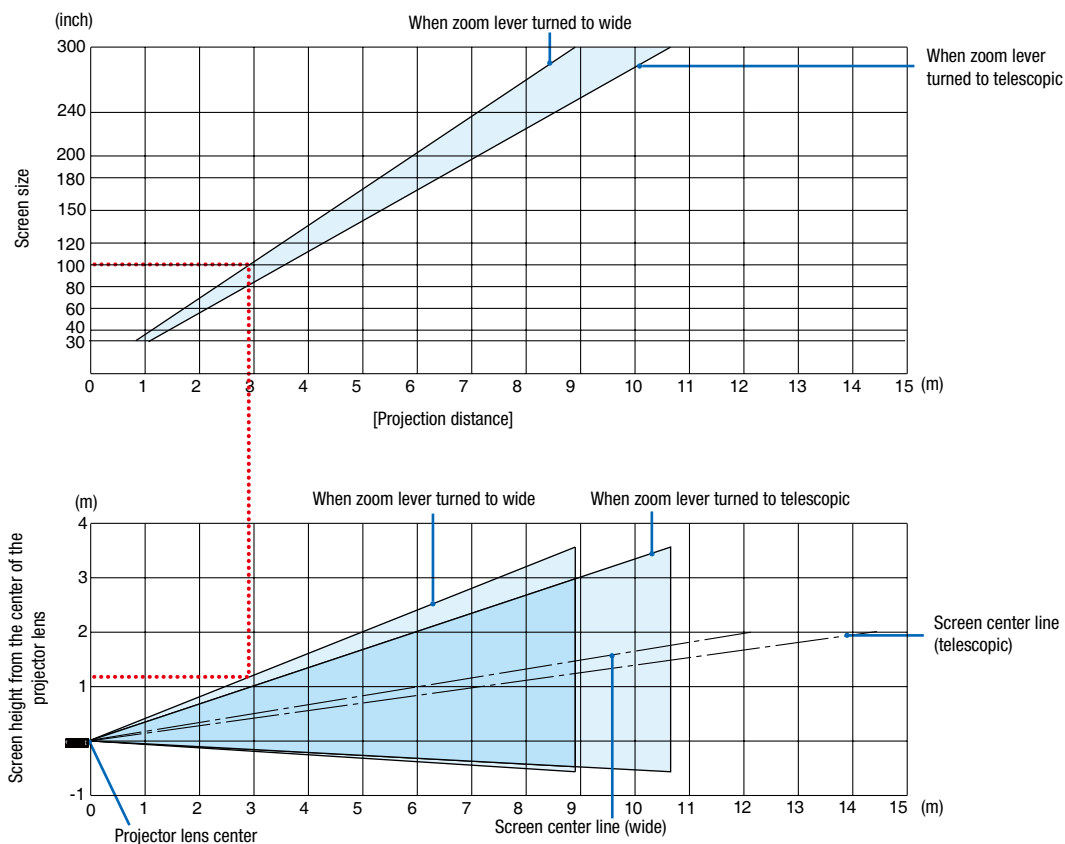

[Reading the Table]

From the upper table on this page, to project wide images on a 100 screen, install at about 3.0 m from the front. Also, from the lower table we can see that about 1.2 m are required from the projector's lens center to the upper edge of the screen. Use this to see whether or not enough height can be provided from the projector to the ceiling and for installing the screen. The diagram shows the projection distance when the projector is installed horizontally.

7. Installation and Connections

The projection distance range at which focusing is possible is 0.8 m (for 30 inches) to 12.9 m (for 300 inches). Install within this range.

[ME403U]

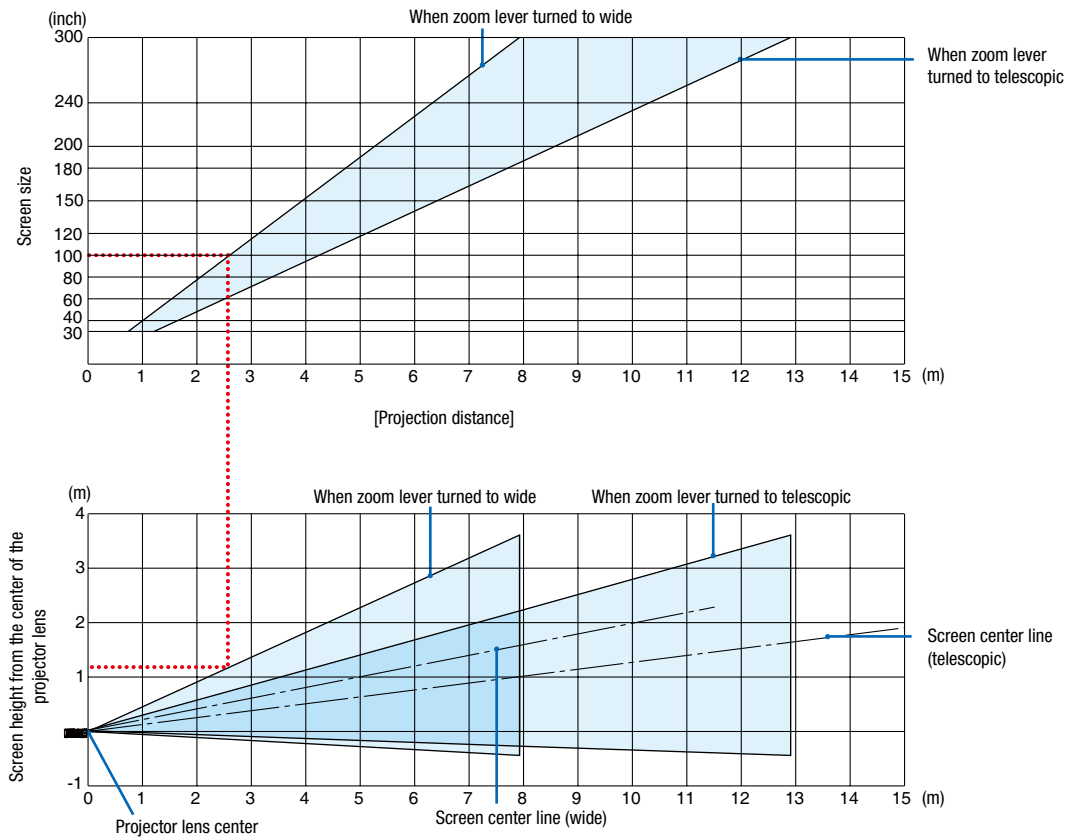

[Reading the Table]

From the upper table on this page, to project wide images on a 100 screen, install at about 2.6 m from the front. Also, from the lower table we can see that about 1.2 m are required from the projector's lens center to the upper edge of the screen. Use this to see whether or not enough height can be provided from the projector to the ceiling and for installing the screen.

7. Installation and Connections

Throw Distance and Screen Size

The following shows the proper relative positions of the projector and screen. Refer to the table to determine the position of installation.

Distance Chart

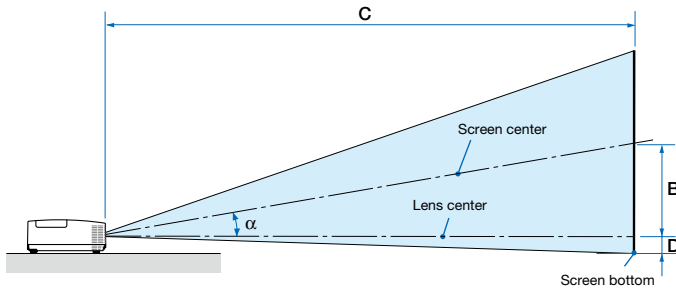

B = Vertical distance between lens center and screen center

C = Throw distance

D = Vertical distance between lens center and screen bottom (top of screen for ceiling application)

α = Throw angle

NOTE: The values in the tables are design values and may vary.

[MC453X]

Screen Size						B		C				D		α			
Diagonal		Width		Height				Wide		Tele				Wide	Tele		
inch	mm	inch	mm	inch	mm	inch	mm	inch	mm	inch	mm	inch	mm	Degree	-	Degree	
30	762	24	610	18	457	6	163	35	900	-	43	1083	-3	-65	10.3	-	8.6
40	1016	32	813	24	610	9	218	47	1204	-	57	1448	-3	-87	10.3	-	8.6
60	1524	48	1219	36	914	13	327	71	1812	-	86	2179	-5	-130	10.2	-	8.5
80	2032	64	1626	48	1219	17	436	95	2421	-	115	2910	-7	-174	10.2	-	8.5
100	2540	80	2032	60	1524	21	545	119	3029	-	143	3641	-9	-217	10.2	-	8.5
120	3048	96	2438	72	1829	26	653	143	3637	-	172	4372	-10	-261	10.2	-	8.5
150	3810	120	3048	90	2286	32	817	179	4550	-	215	5468	-13	-326	10.2	-	8.5
180	4572	144	3658	108	2743	39	980	215	5462	-	258	6564	-15	-391	10.2	-	8.5
200	5080	160	4064	120	3048	43	1089	239	6070	-	287	7295	-17	-435	10.2	-	8.5
240	6096	192	4877	144	3658	51	1307	287	7287	-	345	8756	-21	-522	10.2	-	8.5
270	6858	216	5486	162	4115	58	1470	323	8199	-	388	9853	-23	-587	10.2	-	8.5
300	7620	240	6096	180	4572	64	1634	359	9112	-	431	10949	-26	-652	10.2	-	8.5

[ME453X]

Screen Size						B		C				D		α			
Diagonal		Width		Height				Wide		Tele				Wide	Tele		
inch	mm	inch	mm	inch	mm	inch	mm	inch	mm	inch	mm	inch	mm	Degree	-	Degree	
30	762	24	610	18	457	6	157	31	778	-	52	1327	-3	-71	11.4	-	6.8
40	1016	32	813	24	610	8	210	42	1056	-	70	1788	-4	-95	11.2	-	6.7
60	1524	48	1219	36	914	12	314	63	1612	-	107	2710	-6	-143	11.0	-	6.6
80	2032	64	1626	48	1219	17	419	85	2168	-	143	3632	-8	-191	10.9	-	6.6
100	2540	80	2032	60	1524	21	524	107	2724	-	179	4554	-9	-238	10.9	-	6.6
120	3048	96	2438	72	1829	25	629	129	3280	-	216	5476	-11	-286	10.8	-	6.5
150	3810	120	3048	90	2286	31	786	162	4114	-	270	6859	-14	-357	10.8	-	6.5
180	4572	144	3658	108	2743	37	943	195	4948	-	324	8242	-17	-429	10.8	-	6.5
200	5080	160	4064	120	3048	41	1048	217	5504	-	361	9164	-19	-476	10.8	-	6.5
240	6096	192	4877	144	3658	50	1257	260	6616	-	433	11008	-23	-572	10.8	-	6.5
270	6858	216	5486	162	4115	56	1414	293	7450	-	488	12391	-25	-643	10.8	-	6.5
300	7620	240	6096	180	4572	62	1572	326	8284	-	542	13774	-28	-714	10.7	-	6.5

[ME423W/ME383W]

Screen Size						B		C				D		α			
Diagonal		Width		Height				Wide		Tele				Wide	Tele		
inch	mm	inch	mm	inch	mm	inch	mm	inch	mm	inch	mm	inch	mm	Degree	-	Degree	
30	762	25	646	16	404	6	154	30	755	-	51	1291	-2	-48	11.5	-	6.8
40	1016	34	862	21	538	8	206	40	1025	-	69	1740	-3	-64	11.3	-	6.7
60	1524	51	1292	32	808	12	309	62	1565	-	104	2638	-4	-95	11.2	-	6.7
80	2032	68	1723	42	1077	16	411	83	2105	-	139	3536	-5	-127	11.1	-	6.6
100	2540	85	2154	53	1346	20	514	104	2645	-	175	4434	-6	-159	11.0	-	6.6
120	3048	102	2585	64	1615	24	617	125	3186	-	210	5332	-8	-191	11.0	-	6.6
150	3810	127	3231	79	2019	30	771	157	3996	-	263	6679	-9	-238	10.9	-	6.6
180	4572	153	3877	95	2423	36	926	189	4806	-	316	8025	-11	-286	10.9	-	6.6
200	5080	170	4308	106	2692	40	1028	210	5346	-	351	8923	-13	-318	10.9	-	6.6
240	6096	204	5169	127	3231	49	1234	253	6427	-	422	10719	-15	-381	10.9	-	6.6
270	6858	229	5816	143	3635	55	1388	285	7237	-	475	12066	-17	-429	10.9	-	6.6
300	7620	254	6462	159	4039	61	1543	317	8048	-	528	13413	-19	-477	10.8	-	6.6

7. Installation and Connections

[MC393W]

Diagonal		Screen Size				B		C				D		α			
		Width		Height				Wide		Tele				Wide		Tele	
inch	mm	inch	mm	inch	mm	inch	mm	inch	mm	-	inch	mm	inch	mm	Degree	-	Degree
30	762	25	635	16	406	7	174	38	955	-	45	1149	-1	-29	10.3	-	8.6
40	1016	34	864	21	533	9	229	50	1277	-	60	1536	-2	-38	10.2	-	8.5
60	1524	51	1295	32	813	14	348	76	1922	-	91	2311	-2	-58	10.2	-	8.5
80	2032	68	1727	42	1067	18	457	101	2567	-	121	3086	-3	-77	10.2	-	8.5
100	2540	85	2159	53	1346	23	577	126	3211	-	152	3860	-4	-96	10.2	-	8.5
120	3048	102	2591	64	1626	27	697	152	3856	-	182	4635	-5	-115	10.2	-	8.5
150	3810	127	3226	79	2007	34	860	190	4823	-	228	5797	-6	-144	10.2	-	8.5
180	4572	153	3886	95	2413	41	1035	228	5790	-	274	6959	-7	-173	10.2	-	8.5
200	5080	170	4318	106	2692	45	1154	253	6435	-	304	7733	-8	-192	10.2	-	8.5
240	6096	204	5182	127	3226	54	1383	304	7725	-	365	9283	-9	-230	10.2	-	8.5
270	6858	229	5817	143	3632	61	1557	342	8692	-	411	10445	-10	-259	10.2	-	8.5
300	7620	254	6452	159	4039	68	1732	380	9659	-	457	11607	-11	-288	10.2	-	8.5

[MC423W]

Diagonal		Screen Size				B		C				D		α			
		Width		Height				Wide		Tele				Wide		Tele	
inch	mm	inch	mm	inch	mm	inch	mm	inch	mm	-	inch	mm	inch	mm	Degree	-	Degree
30	762	25	646	16	404	6	160	34	856	-	41	1046	-2	-42	10.6	-	8.7
40	1016	34	862	21	538	8	214	45	1153	-	55	1403	-2	-55	10.5	-	8.7
60	1524	51	1292	32	808	13	321	69	1748	-	83	2117	-3	-83	10.4	-	8.6
80	2032	68	1723	42	1077	17	428	92	2342	-	111	2831	-4	-111	10.3	-	8.6
100	2540	85	2154	53	1346	21	534	116	2937	-	140	3545	-5	-139	10.3	-	8.6
120	3048	102	2585	64	1615	25	641	139	3531	-	168	4260	-7	-166	10.3	-	8.6
150	3810	127	3231	79	2019	32	802	174	4423	-	210	5331	-8	-208	10.3	-	8.6
180	4572	153	3877	95	2423	38	962	209	5314	-	252	6402	-10	-250	10.3	-	8.5
200	5080	170	4308	106	2692	42	1069	233	5909	-	280	7116	-11	-277	10.3	-	8.5
240	6096	204	5169	127	3231	50	1283	279	7097	-	336	8544	-13	-333	10.2	-	8.5
270	6858	229	5816	143	3635	57	1443	315	7989	-	379	9615	-15	-374	10.2	-	8.5
300	7620	254	6462	159	4039	63	1603	350	8881	-	421	10686	-16	-416	10.2	-	8.5

[ME403U]

Diagonal		Screen Size				B		C				D		α			
		Width		Height				Wide		Tele				Wide		Tele	
inch	mm	inch	mm	inch	mm	inch	mm	inch	mm	-	inch	mm	inch	mm	Degree	-	Degree
30	762	25	646	16	404	6	154	29	745	-	49	1240	-2	-48	11.7	-	7.1
40	1016	34	862	21	538	8	206	40	1012	-	66	1670	-3	-64	11.5	-	7.0
60	1524	51	1292	32	808	12	309	61	1545	-	100	2532	-4	-95	11.3	-	6.9
80	2032	68	1723	42	1077	16	411	82	2079	-	134	3393	-5	-127	11.2	-	6.9
100	2540	85	2154	53	1346	20	514	103	2612	-	167	4254	-6	-159	11.1	-	6.9
120	3048	102	2585	64	1615	24	617	124	3145	-	201	5115	-8	-191	11.1	-	6.9
150	3810	127	3231	79	2019	30	771	155	3945	-	252	6407	-9	-238	11.1	-	6.9
180	4572	153	3877	95	2423	36	926	187	4745	-	303	7699	-11	-286	11.0	-	6.9
200	5080	170	4308	106	2692	40	1028	208	5278	-	337	8560	-13	-318	11.0	-	6.9
240	6096	204	5169	127	3231	49	1234	250	6345	-	405	10283	-15	-381	11.0	-	6.8
270	6858	229	5816	143	3635	55	1388	281	7145	-	456	11575	-17	-429	11.0	-	6.8
300	7620	254	6462	159	4039	61	1543	313	7945	-	507	12867	-19	-477	11.0	-	6.8

WARNING

- Installing your projector on the ceiling must be done by a qualified technician. Contact your Dukane dealer for more information.
- Do not attempt to install the projector yourself.
- Only use your projector on a solid, level surface. If the projector falls to the ground, you can be injured and the projector severely damaged.
- Do not use the projector where temperatures vary greatly. The projector must be used at temperatures between 41°F (5°C) and 104°F (40°C) (Eco mode selected automatically at 95°F to 104°F/35°C to 40°C).
- Do not expose the projector to moisture, dust, or smoke. This will harm the screen image.
- Ensure that you have adequate ventilation around your projector so heat can dissipate. Do not cover the vents on the side or the front of the projector.

② Making Connections

Connecting Your Computer

Computer cables, HDMI can be used to connect to a computer. The connection cable is not enclosed with the projector. Please get ready a suitable cable for the connection.

NOTE: Signals supported by Plug & Play (DDC2)

INPUT		
COMPUTER IN	HDMI 1 IN	HDMI 2 IN
analog	digital	digital
Yes	Yes	Yes

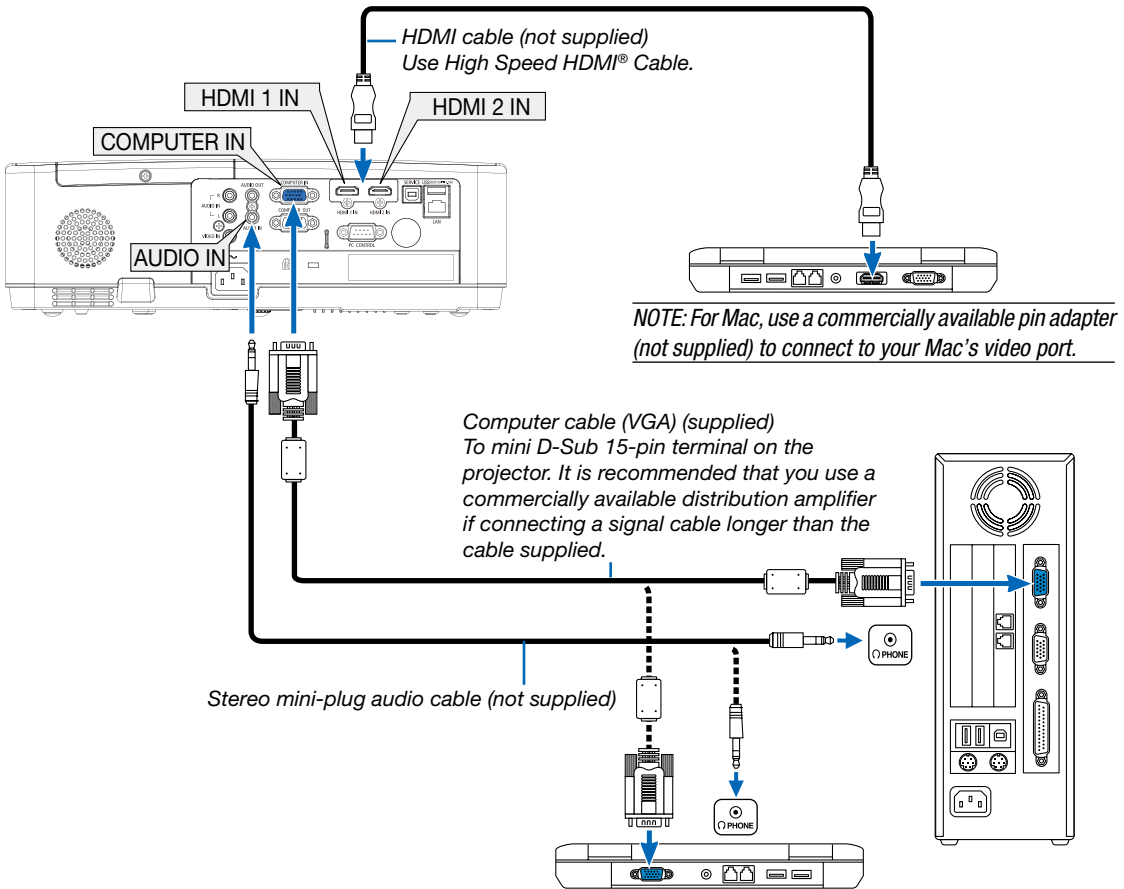

- Select the source name for its appropriate input terminal after turning on the projector.

Input terminal	INPUT button on the projector cabinet	Button on the remote control
COMPUTER IN	COMPUTER	(COMPUTER)
HDMI 1 IN	HDMI1	(HDMI 1)
HDMI 2 IN	HDMI2	(HDMI 2)

7. Installation and Connections

NOTE: The projector is not compatible with video decoded outputs of the ISS-6020 switcher.

NOTE: An image may not be displayed correctly when a Video source is played back via a commercially available scan converter. This is because the projector will process a video signal as a computer signal at the default setting. In that case, do the following.

* *When an image is displayed with the lower and upper black portion of the screen or a dark image is not displayed correctly:*

Project an image to fill the screen and then press the AUTO ADJ. button on the remote control or the projector cabinet.

Enabling the computer's external display

Displaying an image on the notebook PC's screen does not necessarily mean it outputs a signal to the projector.

When using a PC compatible laptop, a combination of function keys will enable/disable the external display.

Usually, the combination of the "Fn" key along with one of the 12 function keys gets the external display to come on or off. For example, laptops use Fn + F3, while Dell laptops use Fn + F8 key combinations to toggle through external display selections.

Cautions when using a DVI signal

- When the computer has a DVI output terminal, use a commercially available converter cable to connect the computer to the projector's HDMI 1 or HDMI 2 input terminal (only digital video signals can be input).

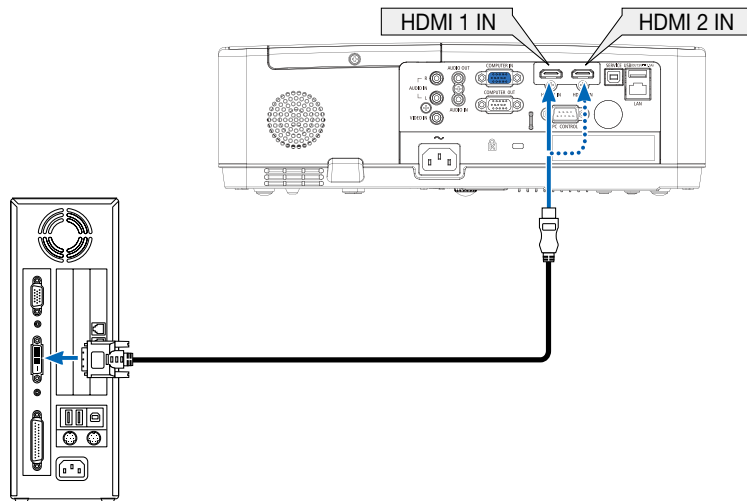

NOTE: When Viewing a DVI Digital Signal

- Turn off the power of the computer and projector before connecting.
- When a video deck is connected via a scan converter, etc., the display may not be correct during fast-forwarding and rewinding.
- Use a DVI-to-HDMI cable compliant with DDWG (Digital Display Working Group) DVI (Digital Visual Interface) revision 1.0 standard. The cable should be within 197"/5 m long.
- Turn off the projector and the PC before connecting the DVI-to-HDMI cable.
- To project a DVI digital signal: Connect the cables, turn the projector on, then select the HDMI input. Finally, turn on your PC. Failure to do so may not activate the digital output of the graphics card resulting in no picture being displayed. Should this happen, restart your PC.
- Do not disconnect the DVI-to-HDMI cable while the projector is running. If the signal cable has been disconnected and then reconnected, an image may not be correctly displayed. Should this happen, restart your PC.
- The COMPUTER video input terminals support Windows Plug and Play.
- A Mac signal adapter (commercially available) may be required to connect a Mac computer.

Connecting an External Monitor

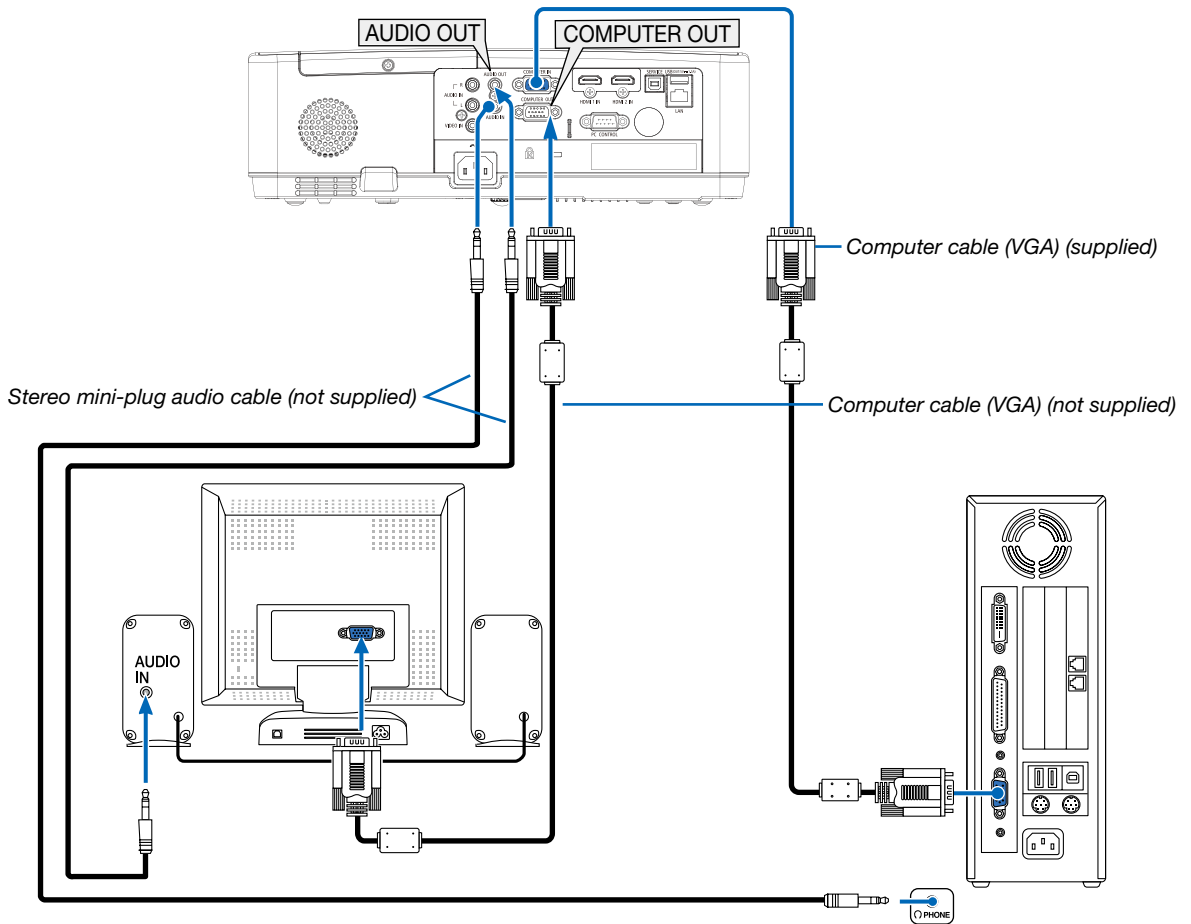

You can connect a separate, external monitor to your projector to simultaneously view on a monitor the computer analog image you're projecting.

NOTE:

- The **AUDIO OUT** mini jack does not support earphone/headphone terminal.
- When audio equipment is connected, the projector speaker is disabled.
- The signal output from the **COMPUTER OUT** of this projector is for projecting image on exclusive one display.

Connecting Your DVD Player or Other AV Equipment

Connecting Video Input

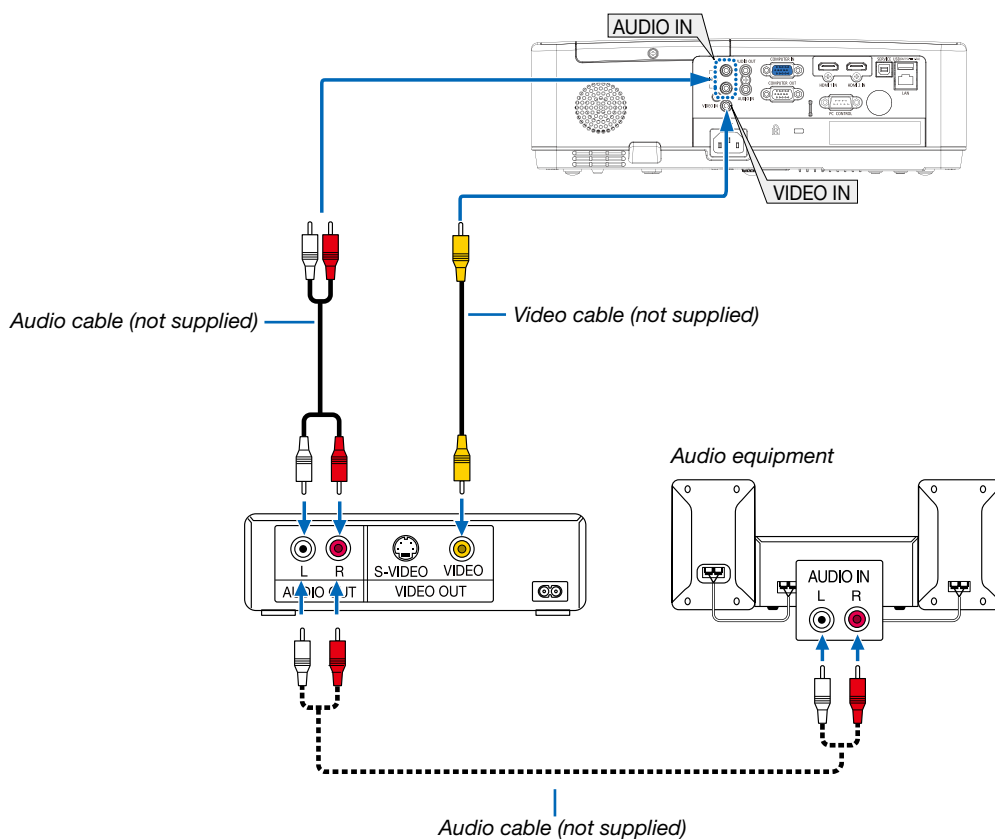

- Select the source name for its appropriate input terminal after turning on the projector.

Input terminal	INPUT button on the projector cabinet	Button on the remote control
VIDEO IN	VIDEO	(VIDEO)

NOTE: Refer to your VCR owner's manual for more information about your equipment's video output requirements.

NOTE: An image may not be displayed correctly when a Video source is played back in fast-forward or fast-rewind via a scan converter.

Connecting Component Input

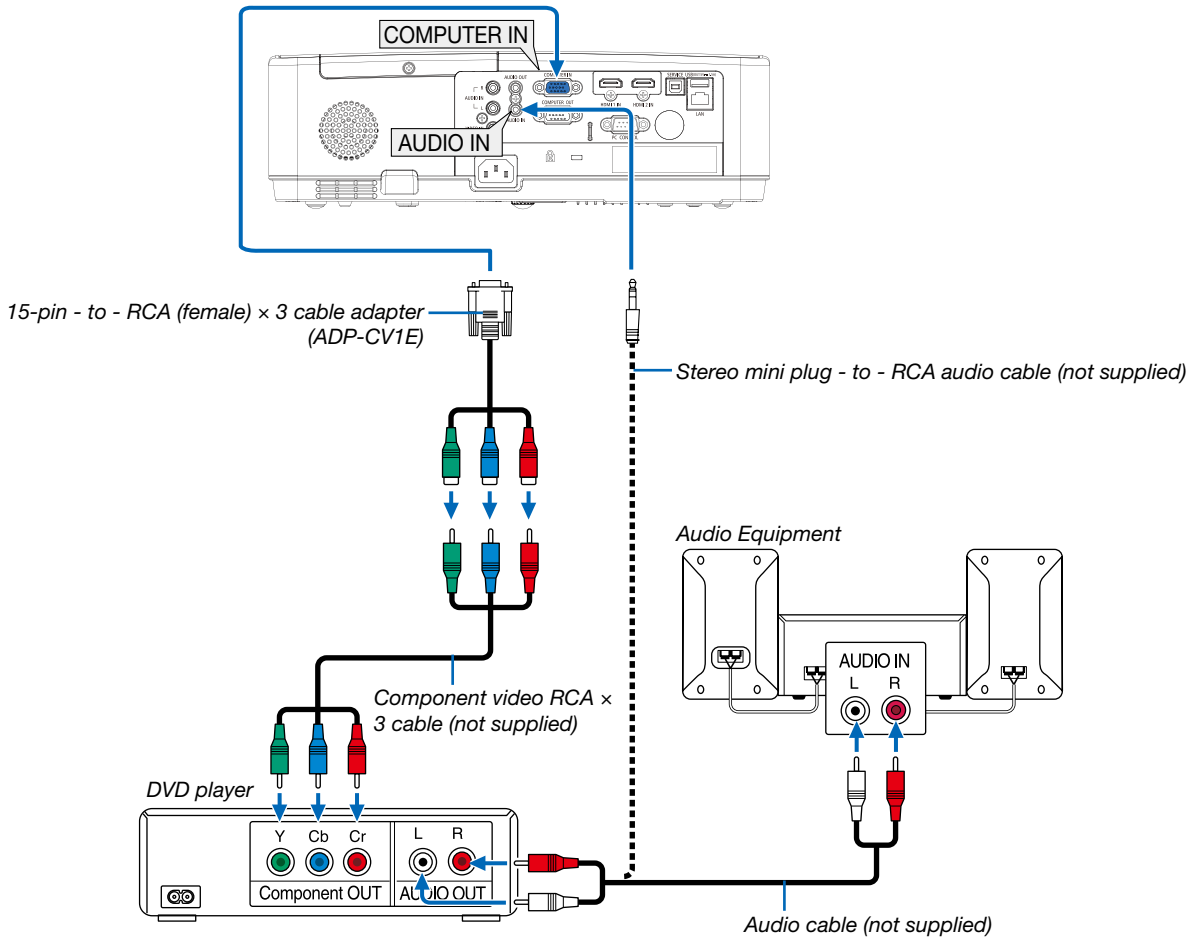

- Select the source name for its appropriate input terminal after turning on the projector.

Input terminal	INPUT button on the projector cabinet	Button on the remote control
COMPUTER IN	 COMPUTER	(COMPUTER)

NOTE: Refer to your DVD player's owner's manual for more information about your DVD player's video output requirements.



7. Installation and Connections

Connecting HDMI Input

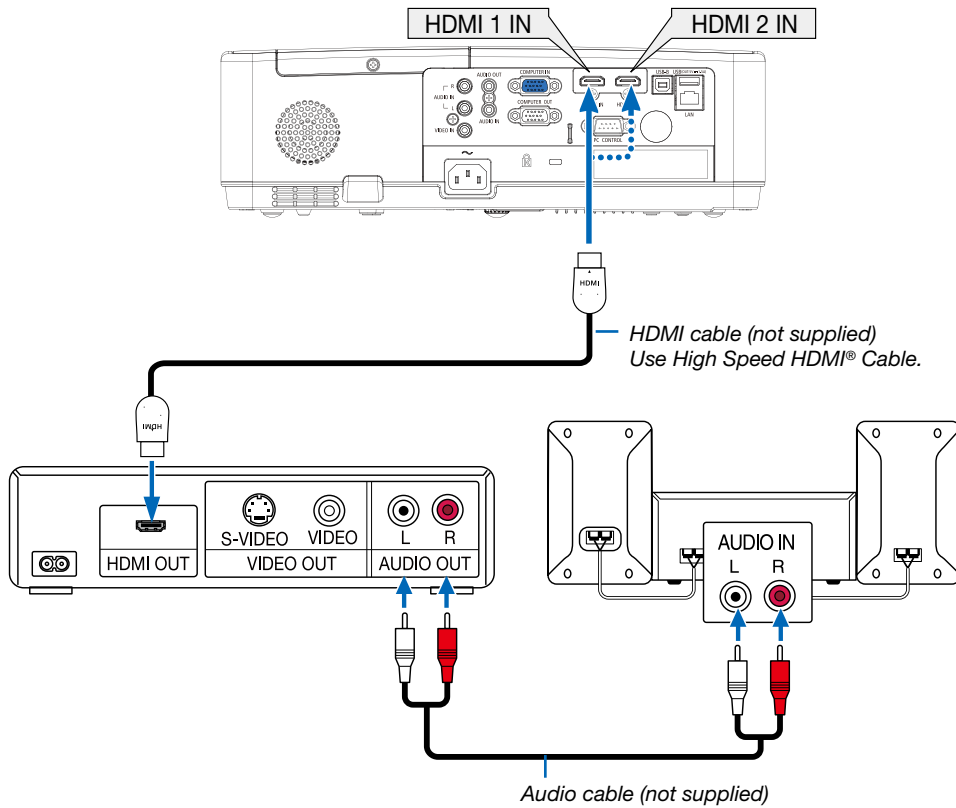
You can connect the HDMI output of your DVD player, hard disk player, Blu-ray player, or notebook type PC to the HDMI IN terminal of your projector.



- Select the source name for its appropriate input terminal after turning on the projector.

Input terminal	INPUT button on the projector cabinet	Button on the remote control
HDMI 1 IN	 HDMI1	(HDMI1)
HDMI 2 IN	 HDMI2	(HDMI2)

Connecting to a Wired LAN

The projector comes standard with a LAN port (RJ-45) which provides a LAN connection using a LAN cable. To use a LAN connection, you are required to set the LAN on the projector menu. (→ page 51)

Example of LAN connection

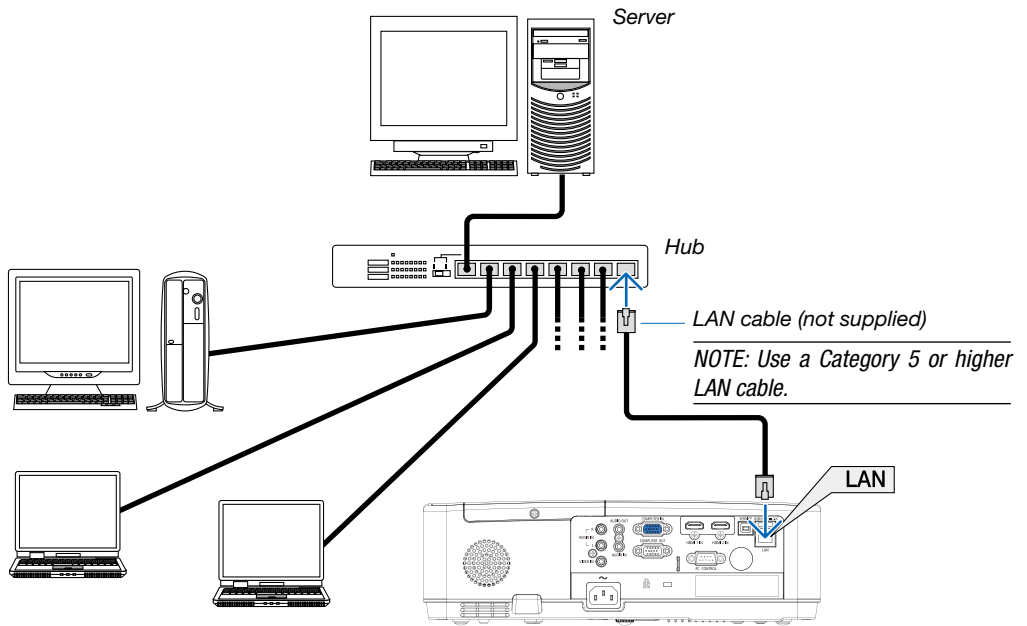

Connecting to a Wireless LAN (Optional: NP05LM series)

The USB Wireless LAN Unit also provides a wireless LAN connection.

Important:

- If you use the projector with the USB Wireless LAN Unit in the area where the use of wireless LAN equipment is prohibited, remove the USB Wireless LAN Unit from the projector.
- Buy the appropriate USB Wireless LAN Unit for your country or area.

NOTE:

- The green LED on the USB Wireless LAN Unit flashes to show that the USB Wireless LAN Unit is working.
- Your computer's wireless LAN adapter (or unit) must be complied with IEEE802.11b/g/n standard.

Attaching the USB Wireless LAN Unit

NOTE:

- The USB Wireless LAN Unit must be inserted into the USB Wireless LAN Unit port in the correct direction. It cannot be inserted in the reverse direction. If the USB Wireless LAN Unit is inserted in the reverse direction with excessive force applied, the USB port may break.
- Before touching the USB Wireless LAN Unit, touch a metallic object (such as a door knob or aluminum window frame) to discharge the static electricity from your body.
- Always insert or remove the USB Wireless LAN unit when the main power is turned off. Failure to do so may cause projector malfunction or damage to the USB wireless LAN unit. If the projector will not work correctly, turn off the projector, disconnect the power cord, and then connect it again.
- The USB port of the projector is common use for the VIEWER. When the USB memory is installed and activate the VIEWER, you can not utilize wireless LAN.

7. Installation and Connections

1. Press the **POWER** button to turn off the projector and set it into standby condition, and disconnect the power cord.
2. Slowly insert the **USB Wireless LAN Unit** into the **USB port**. Remove the cap from the USB Wireless LAN Unit, and then insert it with the surface (side of indicator) facing down. Keep the cap for later use.

NOTE:

- Do not force to insert the USB Wireless LAN Unit.
- Set the supplied strap onto the strap fixing hole for the measure of anti-theft and dropping-off.

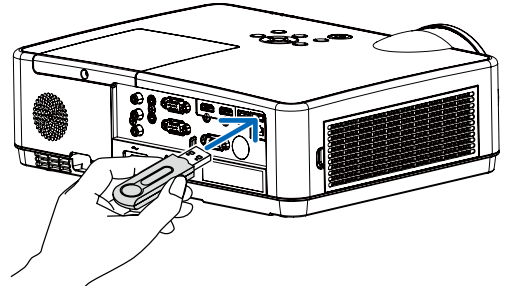

To remove the USB Wireless LAN Unit, disconnect the power cord and use the above procedure.

NOTE:

- The green LED on the USB Wireless LAN Unit flashes to show that Wireless LAN Unit is working. If the USB Wireless LAN Unit is incorrectly attached, the blue LED will not flash.
- Do not press the button on the USB Wireless LAN Unit. The button will not work with this model.

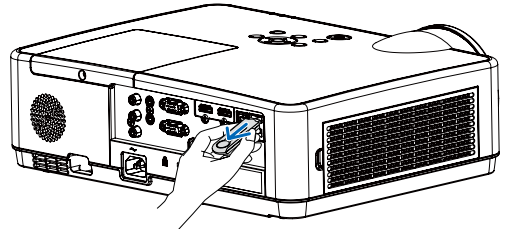

Connection Example [SIMPLE ACCESS POINT]

Set the projector as SIMPLE ACCESS POINT for connecting to terminals as computers and smart phones.

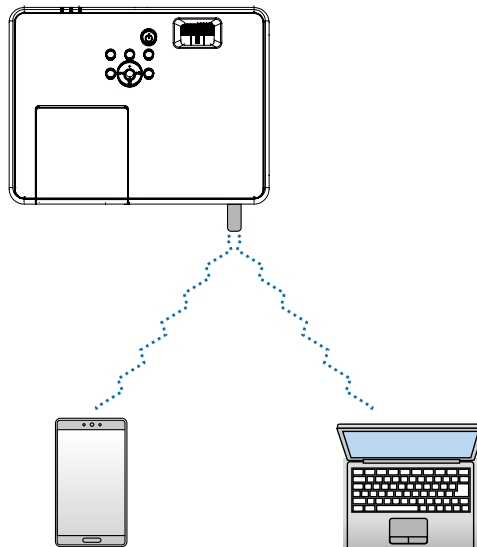

7. Installation and Connections

1. Connect a computer to the projector via wired LAN. (→ page 57)
2. Use the computer's browser to display the projector's HTTP server. (→ page 61)
3. Use an HTTP server to set the wireless LAN. (→ page 57)

NOTE:

- *To use the HTTP server function, the projector must be connected to a network. First, connect the projector to a network by the wired LAN and then perform required settings for the wireless LAN on the HTTP server.*
 - *Data transmission between wireless LAN and wired LAN is not possible.*
-

If you want to change the wireless LAN setting on the projector after setting it on the HTTP server, perform setting change on the on-screen menu.(→ page 57)

8. Connecting to a Network

① Things you can do by connecting the projector to a network

- You can send screen images via a wired LAN/wireless LAN from a terminal installed with our MultiPresenter app to the projector and project them onto a screen.
- Using the web browser of a computer and tablet terminal connected to a wired LAN/wireless LAN, you can connect the projector to a HTTP server to control the projector or configure the NETWORK SETTINGS.

② Connecting to MultiPresenter

Preparations:

- When connecting the projector to a wired LAN, connect a LAN cable to the projector. (→ page 77)
- When connecting the projector to a wireless LAN, install a separately-sold (or the enclosed) LAN unit (NP05LM) in the projector. (→ page 77)
- Configure the NETWORK SETTINGS of the projector. (→ page 57)
- Install the MultiPresenter app in the computer or tablet terminal.

① When connecting using a Wired LAN

1. Turn on the power of the projector and press the APPS button on the remote control.

The start-up screen of MultiPresenter is displayed.

2. Start MultiPresenter.

The target device screen is displayed.

3. Enter the 4-digit PIN code displayed in the start-up screen in the target device screen.

When connection with the projector is completed, the screen of the computer or tablet terminal is projected on the screen.

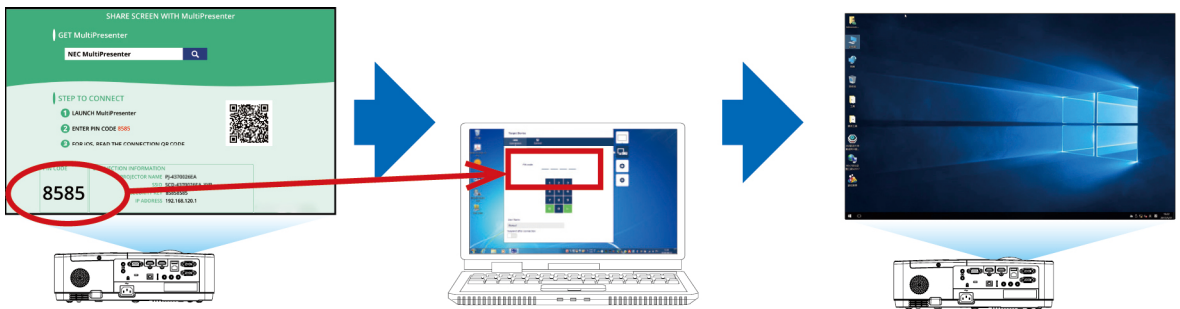

② When connecting using a Wireless LAN

1. Turn on the power of the projector and press the APPS button on the remote control.

The start-up screen of MultiPresenter is displayed.

2. Connect your computer or tablet terminal to the access point matching the "SSID" displayed in the start-up screen.

3. Start MultiPresenter.

The target device screen is displayed.

4. Enter the 4-digit PIN code displayed in the start-up screen in the target device screen.

When connection with the projector is completed, the screen of the computer or tablet terminal is projected on the screen.

9. Maintenance

This section describes the simple maintenance procedures you should follow to clean the filter, the lens, the cabinet, and to replace the lamp and the filter.

① Cleaning the Filter

The air-filter sponge keeps dust and dirt from getting inside the projector and should be frequently cleaned. If the filter is dirty or clogged, your projector may overheat.

⚠ WARNING

- Please do not use a spray containing flammable gas to remove dust attached to the filter, etc. Doing so may result in fires.

NOTE: The message for filter cleaning will be displayed for one minute after the projector is turned on or off. When the message is displayed, clean the filter. The time to clean the filter is set to [10000 H] at time of shipment. To cancel the message, press any button on the projector cabinet or the remote control.

To clean the filter, detach the filter unit and the filter cover.

⚠ CAUTION

- Before cleaning the filter, turn off the projector, disconnect the power cord and then allow the cabinet to cool. Failure to do so can result in electric shock or burn injuries.

1. Push button to release the filter unit and pull it out.

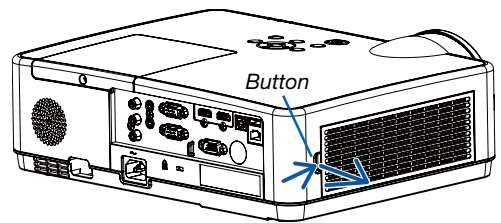

2. Remove the filter.

- Remove the filter from the filter cover.

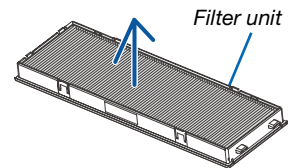

3. Remove dust from the filter and the filter cover.

- Clean both outside and inside.

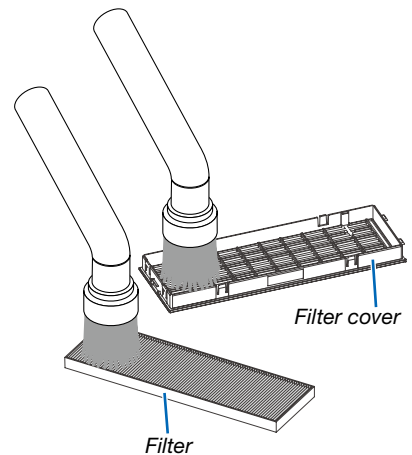

4. Attach the filter to the filter cover.

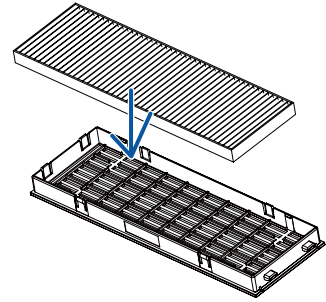

5. Put the filter unit back to the projector cabinet.

Insert two catches of the tip of the filter unit into the groove of the cabinet, and push the button to close the filter unit.

- Push the filter unit until it clicks into place.

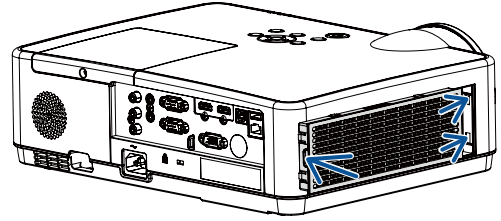

6. Clear the filter usage hours.

Plug the power cord into the wall outlet, and then turn on the projector.

From the menu, select [Filter] → [Filter counter reset].
(→ page 53)

The interval time to clean the filter is set to [OFF] at time of shipment. When using the projector as it is, you do not clear the filter usage.

② Cleaning the Lens

- Turn off the projector before cleaning.
- The projector has a plastic lens. Use a commercially available plastic lens cleaner.
- Do not scratch or mar the lens surface as a plastic lens is easily scratched.
- Never use alcohol or glass lens cleaner as doing so will cause damage to the plastic lens surface.

⚠ WARNING

- Please do not use a spray containing flammable gas to remove dust attached to the lens, etc. Doing so may result in fires.

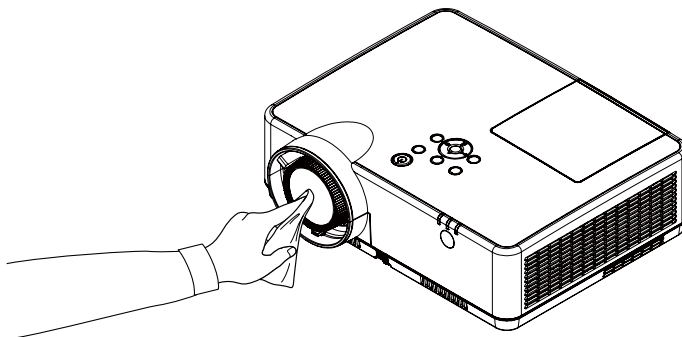

③ Cleaning the Cabinet

Turn off the projector, and unplug the projector before cleaning.

- Use a dry soft cloth to wipe dust off the cabinet.
If heavily soiled, use a mild detergent.
- Never use strong detergents or solvents such as alcohol or thinner.
- When cleaning the vents or the speaker using a vacuum cleaner, do not force the brush of the vacuum cleaner into the slits of the cabinet.

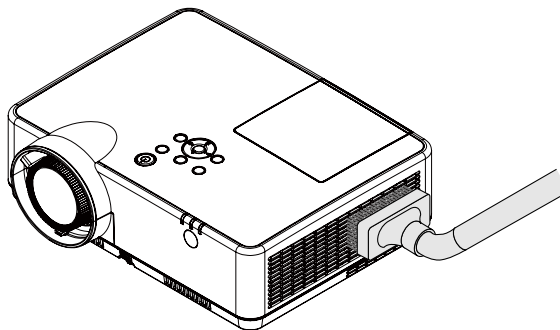

Vacuum the dust off the vents.

- Clogged vents may cause a rise in the internal temperature of the projector, resulting in malfunction.
- Do not scratch or hit the cabinet with your fingers or any hard objects.
- Contact your dealer for cleaning the inside of the projector.

NOTE: Do not apply volatile agent such as insecticide on the cabinet, the lens, or the screen. Do not leave a rubber or vinyl product in prolonged contact with it. Otherwise the surface finish will be deteriorated or the coating may be stripped off.

4 Replacing the Lamp and the Filter

Your projector's lamp is a consumable. you can confirm your usage time according to "Lamp counter" on the Info. menu. (→ page 56)

you'd better ask a professional technician to replace the lamp, contact your Dukane dealer for lamp replacement.

CAUTION

- DO NOT TOUCH THE LAMP immediately after it has been used. It will be extremely hot. Turn the projector off and then disconnect the power cord. Allow at least one hour for the lamp to cool before handling.

- Use the specified lamp for safety and performance.
To order the replacement lamp, specify your lamp type, NP47LP.
The replacement lamp comes with filters.
- DO NOT REMOVE ANY SCREWS except one lamp cover screw and three lamp housing screws. You could receive an electric shock.
- Do not break the glass on the lamp housing.
Keep finger prints off the glass surface on the lamp housing. Leaving finger prints on the glass surface might cause an unwanted shadow and poor picture quality.
- The lamp warning icon displays when its usage time are more than the replacement period of the lamp minus 300H and less than the life of the projector.
- The lamp replacement icon displays when its usage time are more than the replacement period of the lamp. If this happens, be sure to replace the lamp. If you continue to use the lamp after the lamp reaches the end of its life, the lamp bulb may shatter, and pieces of glass may be scattered in the lamp case. Do not touch them as the pieces of glass may cause injury. If this happens, contact your Dukane dealer for lamp replacement.

The lamp warning icon



The lamp replacement icon

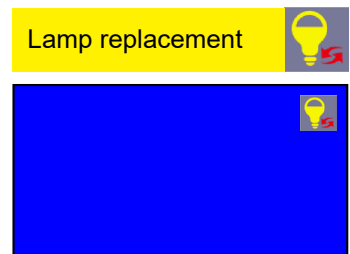

Optional lamp and tools needed for replacement:

- Phillips screwdriver (plus-head)
- Replacement lamp

Flow of Replacing the Lamp and the Filter

Step 1. *Replace the lamp* (→ page 86)

Step 2. *Replace the filter* (→ page 88)

Step 3. *Clear the lamp usage hours and the filter usage hours* (→ page 89)

To replace the lamp:

1. Remove the lamp cover.

- (1) Loosen the lamp cover screw.
 - The lamp cover screw is not removable.
- (2) Push and slide the lamp cover off.

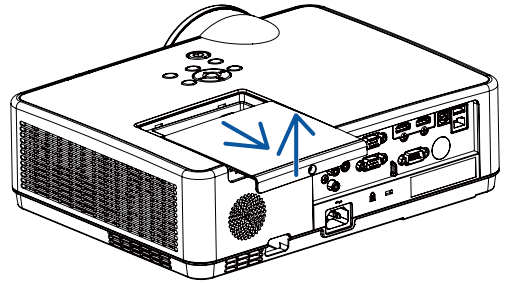
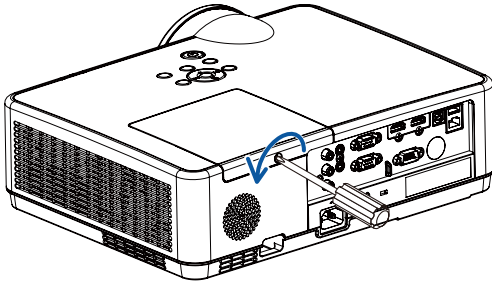

2. Remove the lamp housing.

- (1) Loosen the three screws securing the lamp housing until the phillips screwdriver goes into a freewheeling condition.
 - The three screws are not removable.
 - One of the screws is interlocked to prevent electric shock. Do not attempt to circumvent this interlock.
- (2) Remove the lamp housing by holding it.



CAUTION:

Make sure that the lamp housing is cool enough before removing it.

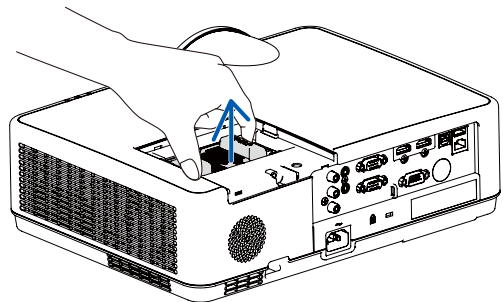
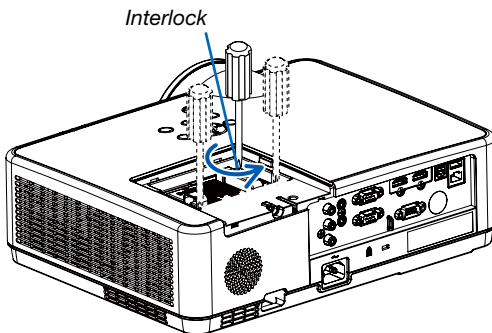

3. Install a new lamp housing.

- (1) Insert a new lamp housing until the lamp housing is plugged into the socket.
- (2) Push the top center of the lamp housing to secure it.
- (3) Secure it in place with the three screws.
 - Be sure to tighten the screws.

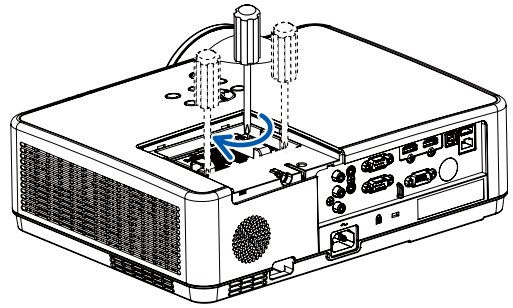
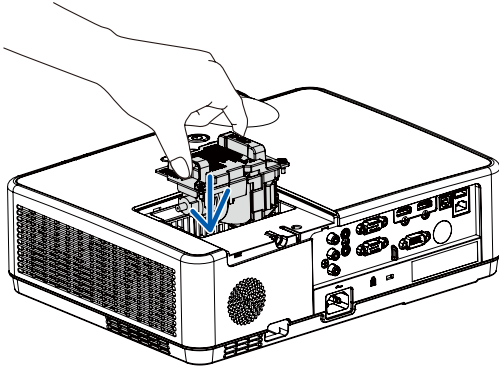

4. Reattach the lamp cover.

- (1) Slide the lamp cover back until it snaps into place.
- (2) Tighten the screw to secure the lamp cover.
 - Be sure to tighten the screw.

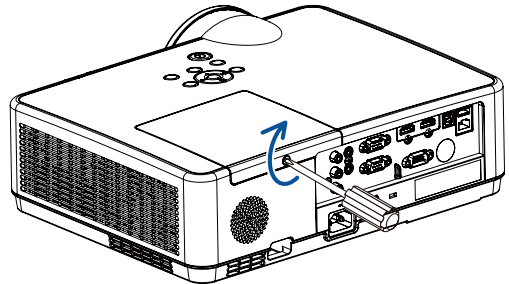
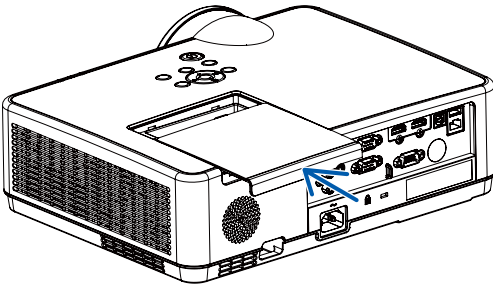

**This completes the lamp replacement.
Go on to the filter replacement.**

To replace the filter:

NOTE:

- Before replacing the filter, wipe off dust and dirt from the projector cabinet.
- The projector is precision equipment. Keep out dust and dirt during filter replacement.
- Do not wash the filter with soap and water. Soap and water will damage the filter membrane.
- Put filter into place. Incorrect attachment of a filter may cause dust and dirt to get into the inside of the projector.

1. Push button to release the filter unit and pull it out.

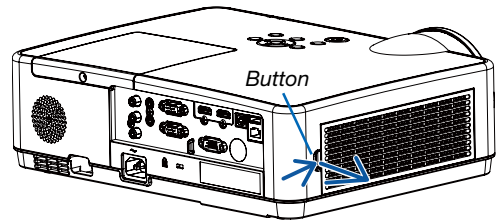

2. Remove the filter.

- Remove the filter from the filter cover.

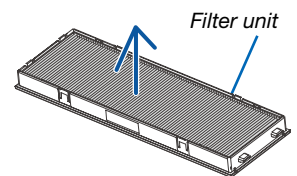

3. Remove dust from the filter cover.

- Clean both outside and inside.

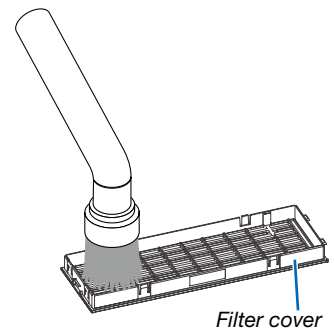

4. Attach a new filter to the filter cover.

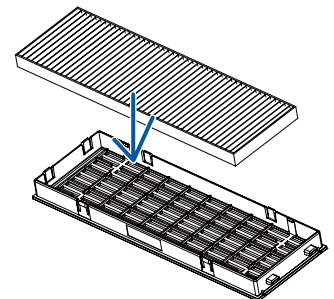

5. Put the filter unit back to the projector cabinet.

Insert two catches of the tip of the filter unit into the groove of the cabinet, and push the button to close the filter unit.

- Push the filter unit until it clicks into place.

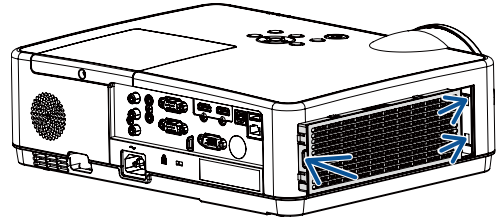

This completes the filter replacement.
Go on to the clearing lamp and filter hour meters.

To clear the lamp usage hours and the filter usage hours:

1. Place the projector where you use it.
2. Plug the power cord into the wall outlet, and then turn on the projector.
3. Clear the lamp usage hours and the filter usage hours.

- 1) Press MENU button and the OSD displays. Press ▲▼ button to select Expand menu, press ► button or ENTER.
- 2) Press ▲▼ button to select "Lamp counter reset", press ► button or ENTER. The "Lamp counter reset?" message displays. Select Yes to proceed.
Press ▲▼ button to select "Filter", press ► button or ENTER. Press ▲▼ button to select "Filter counter reset" and press ENTER. The "Filter counter reset?" message displays. Select Yes to proceed.

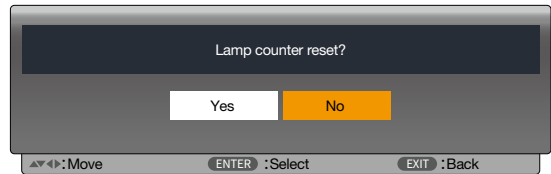
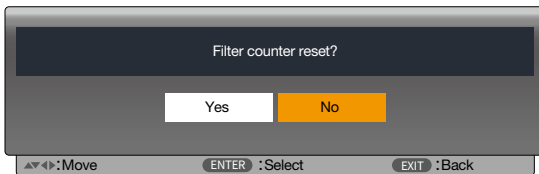

10. Appendix

1 Troubleshooting





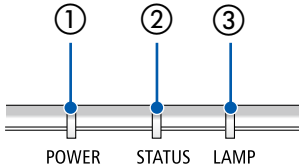





















This section helps you resolve problems you may encounter while setting up or using the projector.

Feature of each indicator



- ① POWER indicator
This indicator informs the power status of the projector.
- ② STATUS indicator
This indicator lights/blinks when a button is pressed while the CONTROL PANEL LOCK function is utilized, or while performing the specific operations.
- ③ LAMP indicator
This indicator informs the state of lamp, usage time of the lamp, and the status of ECO MODE.

Indicator Message (Status message)

POWER	STATUS	LAMP	Projector status
 Off	 Off	 Off	Power is off
 Orange (Blink*2)	 Off	 Off	Standby(Normal)
 Orange	 Off	 Off	Standby(Network)
 Orange (Blink*1)	 Off	 Off	Standby(Sleep)
 Green (Blink*4)	 Off	 Off	Cooling
 Green	 Off	 Off	Power Save Standby
 Blue	 Off	 Green	Lamp ON(Lamp Normal)
 Blue	 Off	 Green (Blink*3)	Lamp ON(Lamp ECO)
 Blue (Blink*4)	 Off	 Off	Warm Up























*1 Repetition to light on for 1.5 seconds / off for 1.5 seconds

*2 Repetition to light on for 1.5 seconds / off for 7.5 seconds

*3 Repetition to light on for 2.5 seconds / off for 0.5 seconds

*4 Repetition to light on for 0.5 seconds / off for 0.5 seconds

Indicator Message (Error message)

POWER	STATUS	LAMP	Projector status	Procedure
 Off	 Orange	 Off	A button has been pressed while the KEY LOCK is activated.	The projector's keys are locked. The setting must be canceled to operate the projector. (→ page 39)
			ID numbers for the projector and the remote control do not match.	Check the control IDs (→ page 52)
Status varies	 Off	 Orange (Blink*4)	Lamp replacement grace period.	The lamp has reached the end of its service life and is now in the replacement grace period (Between lamp life and 110% of lamp life). Replace the lamp to new one as soon as possible. (→ page 85)
Status varies	 Off	 Red (Blink*4)	Lamp replacement time exceeded.	The lamp has exceeded its replacement time (More than 110% of lamp life). Replace the lamp immediately.
 Blue (Blink*4)	 Off	 Green (Blink*4)	Preparing to relight lamp after lighting has failed.	Wait a while.
 Red (Blink*4)	 Off	 Off	Temperature problem	Ambient temperature is out of the operation temperature. Check if any obstruction stays near the exhaust vent.
 Red	 Red (Blink*4)	 Off	Power problem	Please contact your dealer or service personnel.
 Red	 Red	 Off	FAN problem	Please contact your dealer or service personnel.
 Red (Blink*4)	 Green	 Red	Lamp does not light.	Wait at least 1 minute, then turn on the power back on. If the lamp still does not light, contact your dealer or service personnel.

*1 Repetition to light on for 1.5 seconds / off for 1.5 seconds

*2 Repetition to light on for 1.5 seconds / off for 7.5 seconds

*3 Repetition to light on for 2.5 seconds / off for 0.5 seconds

*4 Repetition to light on for 0.5 seconds / off for 0.5 seconds

- When the thermal protector is activated:

When inside temperature of the projector becomes too high or low, the POWER indicator start to red blink in a short cycle. After this happened, the thermal protector will activate and the projector may be turned off.

In this case, please take the below measures:

- Pull out the power plug from the wall inlet.
- Place the projector in cool place if it has been placed in high ambient temperature.
- Clean the exhaust vent if dust has accumulated on.
- Leave the projector for about one hour until inside temperature gets lower.

② Specifications

This section provides technical information about projector's performance.

Optical

Model Number	ME403U	ME423W	ME383W	MC423W	MC393W	ME453X	MC453X
LCD Panel	0.64 inch LCD with Micro Lens Array (Aspect Ratio 16:10)	0.64 inch LCD with Micro Lens Array (Aspect Ratio 16:10)	0.59 inch LCD with Micro Lens Array (Aspect Ratio 16:10)	0.64 inch LCD with Micro Lens Array (Aspect Ratio 16:10)	0.59 inch LCD with Micro Lens Array (Aspect Ratio 16:10)	0.63 inch LCD with Micro Lens Array (Aspect Ratio 4:3)	
Resolution*1	WUXGA (1920 dots × 1200 lines)	WXGA (1280 dots × 800 lines)				XGA (1024 dots × 768 lines)	
Lens	ZOOM Ratio=1.6 F=1.5-2.08 / f=17.2-27.7 mm	ZOOM Ratio=1.7 F=1.7-2.2 / f=17.4-29.0 mm		ZOOM Ratio=1.2 F=1.6-1.8 / f=19.2-23.0 mm	ZOOM Ratio=1.2 F=1.6-1.8 / f=19.2-23.0 mm	ZOOM Ratio=1.7 F=1.7-2.2 / f=17.4-29.0 mm	ZOOM Ratio=1.2 F=1.6-1.8 / f=19.2-23.0 mm
	Zoom	Manual					
	Focus	Manual					
Lamp	Boost	240W					
	Normal	225W					
	ECO1 (Normal ECO mode)	180 W					
	ECO2 (ECO mode)	150 W					
Light Output**2*3		4000 lm	4200 lm	3800 lm	4200 lm	3900 lm	4500 lm
	NORMAL	Approx. 94%					
	ECO1	Approx. 75%					
	ECO2	Approx. 63%					
Contrast Ratio (full white/full black)	16000:1 with Iris						
Screen Size (Diagonal)	30-300 inches						
Projection Distance (Min.-Max.)	29-507 inches / 0.7-12.9 m	30-528 inches / 0.8-13.4 m		34-421 inches / 0.9-10.7 m	38-457 inches / 1.0-11.6 m	31-542 inches / 0.8-13.8 m	35-431 inches / 0.9-10.9 m
Projection Angle	11.0°-11.7° (Wide) / 6.8°-7.1° (Tele)	10.8°-11.5° (Wide) / 6.6°-6.8° (Tele)		10.2°-10.6° (Wide) / 8.5°-8.7° (Tele)	10.2°-10.3° (Wide) / 8.5°-8.6° (Tele)	10.7°-11.4° (Wide) / 6.5°-6.8° (Tele)	10.2°-10.3° (Wide) / 8.5°-8.6° (Tele)

*1 Effective pixels are more than 99.99%.

*2 When ECO1 is selected, the brightness is about 75%.When ECO2 is selected, the brightness is about 63%.

*3 Compliance with ISO21118-2012

Electrical

Model Number	ME403U	ME423W	ME383W	MC423W	MC393W	ME453X	MC453X
Inputs	1 × RGB/Component (D-SUB 15 P), 2 × HDMI Type A (19P, HDMI® Terminal) HDCP supported*4, 1 × Video (RCA), 1 × (L/R) RCA Audio, 1 × Stereo Mini Audio						
Outputs	1 × RGB (D-Sub 15 P), 1 × Stereo Mini Audio						
PC Control	1 × PC Control Port (D-Sub 9 P)						
Wired LAN Port	1 × RJ-45 (10BASE-T/100BASE-TX)						
Wireless LAN Port (Optional)	IEEE 802.11 b/g/n (optional USB Wireless LAN Unit required)						
USB Port	1 × Type A, 1 × Type B						
Color Reproduction	10-bit signal processing (1.07 billion colors) (VIEWER, Network: 16.7 million colors)						

*4 HDMI® (Deep Color, Lip Sync) with HDCP

What is HDCP/HDCP technology?

HDCP is an acronym for High-bandwidth Digital Content Protection. High bandwidth Digital Content Protection (HDCP) is a system for preventing illegal copying of video data sent over a High-Definition Multimedia Interface (HDMI).

If you are unable to view material via the HDMI input, this does not necessarily mean the projector is not functioning properly. With the implementation of HDCP, there may be cases in which certain content is protected with HDCP and might not be displayed due to the decision/intention of the HDCP community (Digital Content Protection, LLC).

Video: Deep Color; 8/10/12-bit, LipSync

Audio: LPCM; up to 2 ch, sample rate 32/44.1/48 KHz, sample bit; 16/20/24-bit

Model Number	ME403U	ME423W	ME383W	MC423W	MC393W	ME453X	MC453X
Compatible Signals*5	Analog: VGA/SVGA/XGA/WXGA/Quad-VGA/SXGA/SXGA+/WXGA+/WXGA++/UXGA/WSXGA+/HD/Full HD/WUXGA/Mac 13", 16", 23" Component: 480i/480p/576i/576p/720p/1080i/1080p HDMI: VGA/SVGA/XGA/WXGA/Quad-VGA/SXGA/SXGA+/WXGA+ /WXGA++/WSXGA+/4K/480p/576p/720p/1080i/1080p						
Horizontal Resolution	540 TV lines: NTSC/PAL 300 TV lines: SECAM						
Scan Rate	Horizontal: 15 kHz to 100 kHz (RGB: 24 kHz or over) Vertical: 24 Hz to 85 Hz						
Sync Compatibility	Separate Sync						
Built-in Speaker	1x16 W (monaural)						
Power Requirement	100 to 240 V AC, 50/60 Hz						
Input Current	3.4-1.4 A		3.3-1.3 A				
Power consumption	ECO1	260 W (100-130 V) 255 W (200-240 V)	250 W (100-130 V) 244 W (200-240 V)				
	ECO2	225 W (100-130 V) 220 W (200-240 V)	215 W (100-130 V) 210 W (200-240 V)				
	NORMAL	315 W (100-130 V) 305 W (200-240 V)	305 W (100-130 V) 293 W (200-240 V)				
	Boost	335 W (100-130 V) 322 W (200-240 V)	320 W (100-130 V) 310 W (200-240 V)				
	STANDBY (NETWORK STANDBY)	0.7 W (100-130 V) 0.8 W (200-240 V)					
	STANDBY (NORMAL)	0.2 W (100-130 V) 0.3 W (200-240 V)					

*5 An image with higher or lower resolution than the projector's native resolution (ME453X/MC453X: 1024 × 768 / ME423W/ME383W/MC423W/MC393W: 1280 × 800 / ME403U: 1920 × 1200) will be displayed with Advanced AccuBlend. (→ page 97)

Mechanical

Model Number	ME403U	ME423W	ME383W	MC423W	MC393W	ME453X	MC453X
Installation Orientation	Desktop/Front, Desktop/Rear, Ceiling/Front, Ceiling/Rear						
Dimensions	345 mm (W) × 113.5 mm (H) × 284.5 mm (D) (including protrusions) 345 mm (W) × 104.6 mm (H) × 261 mm (D) (not including protrusions)	345 mm (W) × 108.4 mm (H) × 261 mm (D) (including protrusions) 345 mm (W) × 104.6 mm (H) × 261 mm (D) (not including protrusions)					
Weight	3.7 kg	3.4 kg		3.3 kg		3.4 kg	3.3 kg
Environmental Considerations	Operational Temperatures: 41° to 104°F (5° to 40°C), (ECO mode selected automatically at 95°F to 104°F/35°C to 40°C) 20% to 80% humidity (non-condensing) Storage Temperatures: 14° to 122°F (-10° to 50°C), 20% to 80% humidity (non-condensing) Operating altitude: 0 to 3000 m/9800 f (Imposta [Altitudine elevata] su [On]. approximately 1700 m/5500 f or higher.)						

For additional information visit:
US : <https://www.dukaneav.com>

For information on our optional accessories, visit our website or see our brochure.

The specifications are subject to change without notice.

3 Cabinet Dimensions

Unit: mm (inch)

[ME403U]

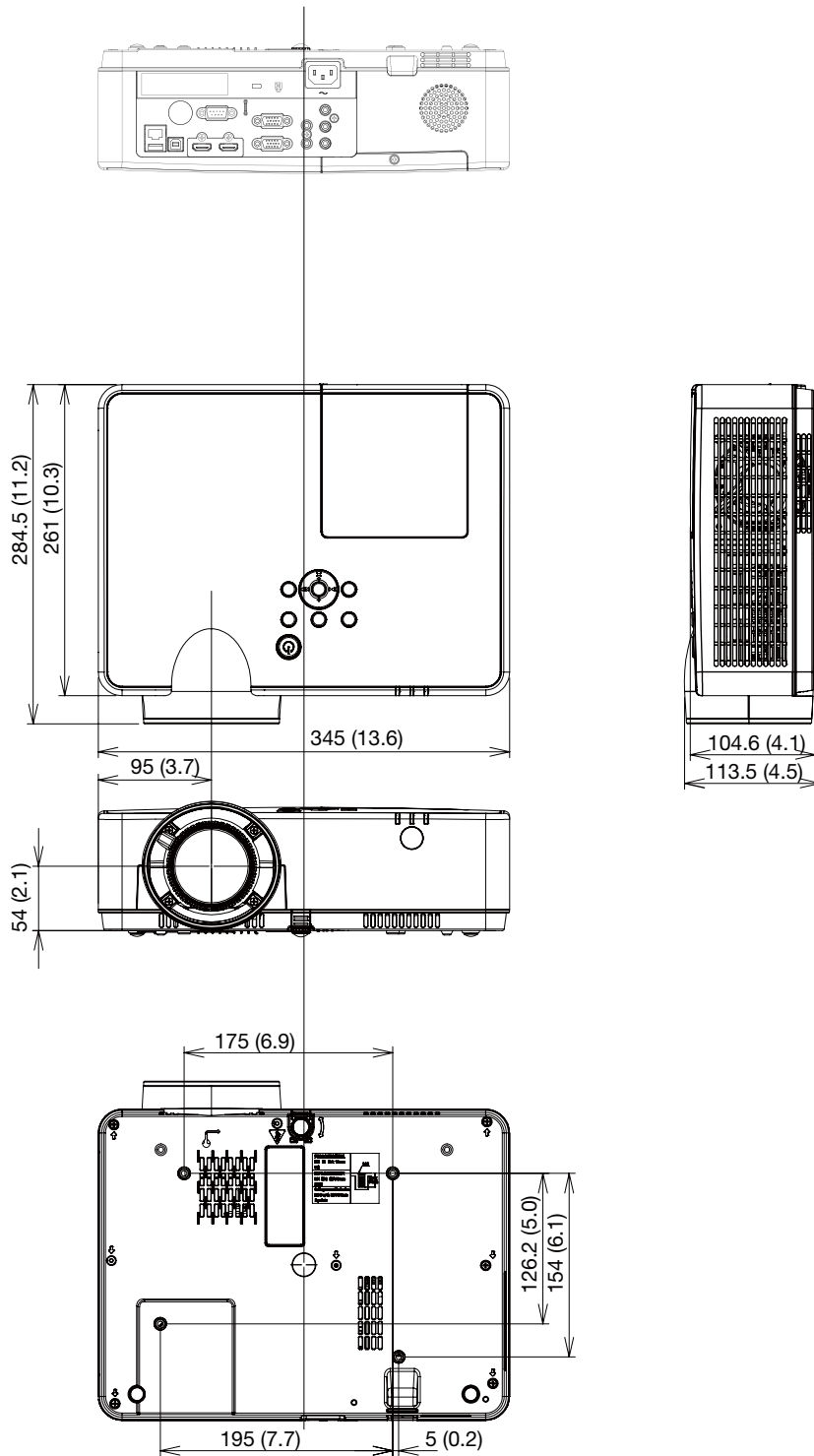

Unit: mm (inch)

[ME423W/ME383W/MC423W/MC393W/ME453X/MC453X]

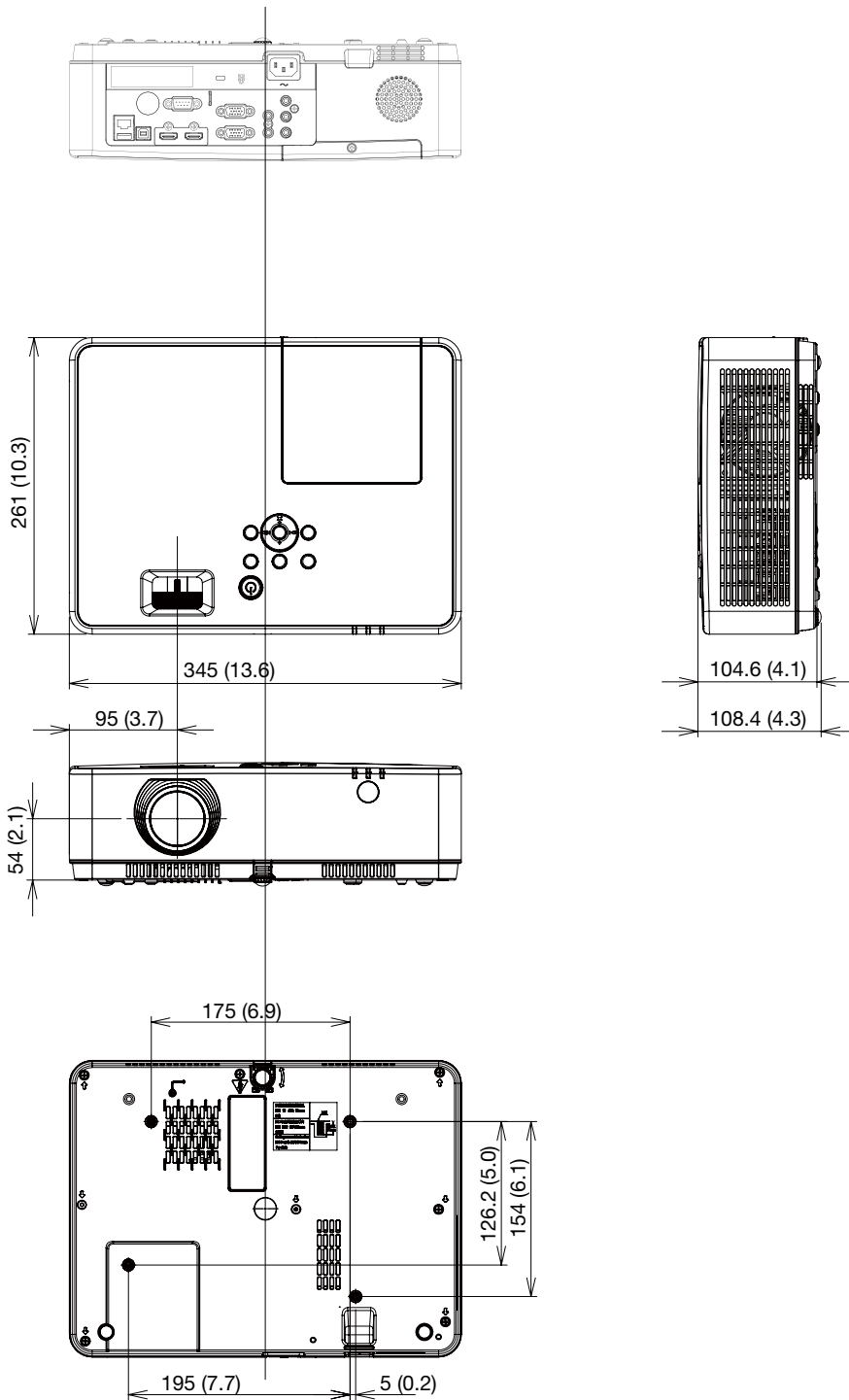

④ Pin Assignments of D-Sub COMPUTER Input Terminal

Mini D-Sub 15 Pin Terminal

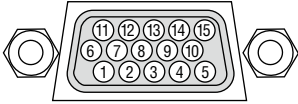

Signal Level

Video signal : 0.7Vp-p (Analog)

Sync signal : TTL level

Pin No.	RGB Signal (Analog)	YCbCr Signal
1	Red	Cr
2	Green or Sync on Green	Y
3	Blue	Cb
4	Ground	
5	Ground	
6	Red Ground	Cr Ground
7	Green Ground	Y Ground
8	Blue Ground	Cb Ground
9	Hotplug	
10	Sync Signal Ground	
11	No Connection	
12	Bi-directional DATA (SDA)	
13	Horizontal Sync or Composite Sync	
14	Vertical Sync	
15	Data Clock	

COMPUTER IN

NOTE: Pin Nos. 12 and 15 are required for DDC/CI.

5 Compatible Input Signal List

No	OSD Display	Source			Specification			
		RGB	HDMI	Video	Resolution	"Pixel clock (MHz)"	H-freq(KHz)	V-freq(Hz)
1	NTSC	—	—	○	NTSC	—	15.734	59.940
	NTSC-443	—	—	○	NTSC 4.43			
	PAL-60	—	—	○	PAL60			
	PAL-M	—	—	○	PAL-M			
2	PAL	—	—	○	PAL	—	15.625	50.000
	PAL-N	—	—	○	PAL-N			
	SECAM	—	—	○	SECAM			
3	720x480i 60Hz	○	—	—	720x480i	13.500	15.734	59.940
4	720x480i 60Hz	—	○	—	720(1440)x480i	27.000	15.734	59.940
5	720x576i 50Hz	○	—	—	720x576i	13.500	15.625	50.000
6	720x576i 50Hz	—	○	—	720(1440)x576i	27.000	15.625	50.000
7	720x483 60Hz	○	○	—	720x483(480P)	27.000	31.469	59.940
8	720x576 50Hz	○	○	—	720x576(576P)	27.000	31.250	50.000
9	1280x720p 60Hz	○	○	—	1280x720p	74.250	45.000	60.000
		○	○	—		74.176	44.955	59.940
10	1280x720p 50Hz	○	○	—		74.250	44.955	50.000
11	1920x1080i 60Hz	○	○	—	1920x1080i	74.250	33.750	60.000
		○	○	—		74.176	33.716	59.940
12	1920x1080i 50Hz	○	○	—		74.250	28.125	50.000
13	1920x1080p 24Hz	—	○	—	1920x1080p	74.250	27.000	24.000
		○	○	—		74.176	26.970	23.980
14	1920x1080p 60Hz	○	○	—	1920x1080p	148.500	67.500	60.000
		○	○	—		148.352	67.433	59.940
15	1920x1080p 50Hz	○	○	—		148.500	56.250	50.000
16	640x480,60Hz	○	○	—	640x480	25.175	31.469	59.940
17	640x480,67Hz	○	○	—		30.240	35.000	66.667
18	640x480,72Hz	○	○	—		31.500	37.861	72.809
19	640x480,75Hz	○	○	—		31.500	37.500	75.000
20	640x480,85Hz	○	○	—		36.000	43.269	85.008
21	800x600,56Hz	○	○	—		800x600	36.000	35.156
22	800x600,60Hz	○	○	—	40.000		37.879	60.317
23	800x600,72Hz	○	○	—	50.000		48.077	72.188
24	800x600,75Hz	○	○	—	49.500		46.875	75.000
25	800x600,85Hz	○	○	—	56.250		53.674	85.061
26	832x624,75Hz	○	○	—	832x624		57.283	49.725
27	1024x768,60Hz	○	○	—	1024x768	65.000	48.363	60.004
28	1024x768,70Hz	○	○	—		75.000	56.476	70.069
29	1024x768,75Hz	○	○	—		78.750	60.023	75.029
30	1024x768,85Hz	○	○	—		94.500	68.678	84.997
31	1152x864,70Hz	○	○	—	1152x864	94.200	63.995	70.020
32	1152x864,75Hz	○	○	—		108.000	67.500	75.000
33	1280x720,60Hz	○	○	—	1280x720	74.500	44.772	59.855
34	1280x768,60Hz	○	○	—	1280x768	79.500	47.776	59.870
35	1280x768,75Hz	○	○	—		102.250	60.289	74.893
36	1280x768,85Hz	○	○	—		117.500	68.630	84.840
37	1280x800,60Hz	○	○	—		1280x800	83.500	49.702
38	1280x800,75Hz	○	○	—	106.500		62.795	74.934
39	1280x800,85Hz	○	○	—	122.500		71.554	84.880
40	1280x960,60Hz	○	○	—	1280x960	108.000	60.000	60.000
41	1280*960, 75Hz	○	○	—		126.000	75.000	75.080

No	OSD Display	Source			Specification			
		RGB	HDMI	Video	Resolution	"Pixel clock (MHz)"	H-freq(KHz)	V-freq(Hz)
42	1280x1024,60Hz	○	○	—	1280x1024	108.000	63.981	60.020
43	1280*1024,65Hz	○	○	—		118.500		65.180
44	1280x1024,72Hz	○	○	—		135.060	78.16	71.97
45	1280x1024,75Hz	○	○	—		135.000	79.976	75.025
46	1280x1024,85Hz	○	○	—		157.500	91.146	85.024
47	1360*768,60Hz	○	○	—	1360x768	85.500	47.710	60.020
48	1366x768,60Hz	○	○	—	1366x768	84.750	47.720	59.799
49	1400x1050,60Hz	○	○	—	1400x1050	121.750	65.317	59.978
50	1400x1050,75Hz	○	○	—		156.000	82.278	74.867
51	1440x900,60Hz	○	○	—	1440x900	106.500	55.935	59.887
52	1600x900,60Hz	○	○	—	1600x900	118.998	55.920	60.000
53	1600x1200,60Hz	○	○	—	1600x1200	162.000	75.000	60.000
54	1680x1050,60Hz	○	○	—	1680x1050	146.250	65.290	59.954
55	1920x1080,60Hz	○	○	—	1920x1080	138.500	66.587	59.934
56	1920x1200,60Hz	○	○	—	1920x1200	154.000	74.038	59.950
57	3840x2160,30Hz	—	○	—	3840x2160	297	67.5	30.000

NOTE:

“○” Shows input signal source support this format.

“—” Shows input signal source DO NOT support.

⑥ PC Control Codes and Cable Connection

PC Control Codes

Function	Code Data								
POWER ON	02H	00H	00H	00H	00H	02H			
POWER OFF	02H	01H	00H	00H	00H	03H			
INPUT SELECT COMPUTER	02H	03H	00H	00H	02H	01H	01H	09H	
INPUT SELECT HDMI1	02H	03H	00H	00H	02H	01H	1AH	22H	
INPUT SELECT HDMI2	02H	03H	00H	00H	02H	01H	1BH	23H	
INPUT SELECT VIDEO	02H	03H	00H	00H	02H	01H	06H	0EH	
INPUT SELECT USB-A	02H	03H	00H	00H	02H	01H	1FH	27H	
INPUT SELECT LAN	02H	03H	00H	00H	02H	01H	20H	28H	
PICTURE MUTE ON	02H	10H	00H	00H	00H	12H			
PICTURE MUTE OFF	02H	11H	00H	00H	00H	13H			
SOUND MUTE ON	02H	12H	00H	00H	00H	14H			
SOUND MUTE OFF	02H	13H	00H	00H	00H	15H			

NOTE: Contact your local dealer for a full list of the PC Control Codes if needed.

Cable Connection

Communication Protocol

Baud rate 38400 bps
 Data length 8 bits
 Parity No parity
 Stop bit One bit
 X on/off None
 Communications procedure..... Full duplex

NOTE: Depending on the equipment, a lower baud rate may be recommended for long cable runs.

PC Control Terminal (D-SUB 9P)

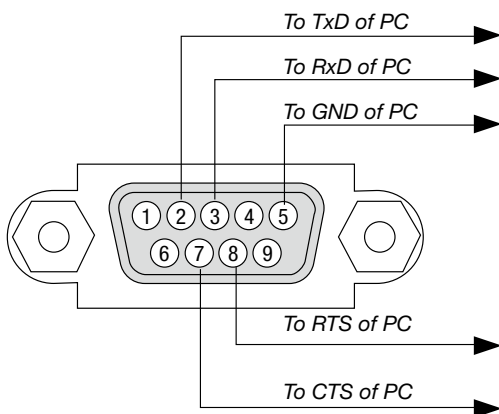

NOTE 1: Pins 1, 4, 6 and 9 are no used.

NOTE 2: Jumper "Request to Send" and "Clear to Send" together on both ends of the cable to simplify cable connection.

NOTE 3: For long cable runs it is recommended to set communication speed within projector menus to 9600 bps.

ABOUT THE ASCII CONTROL COMMAND

This device supports the common ASCII Control Command for controlling our projector and monitor. Please visit our web site for detailed information about the command.

HOW TO CONNECT WITH AN EXTERNAL DEVICE

There are two methods to connect the projector with an external device such as a computer.

1. Connection thru the serial port.
Connects the projector to a computer by a serial cable (a cross cable).
2. Connection via network (LAN)
Connects the projector to a computer by a LAN cable.
Concerning to the type of LAN cable, please ask to your network administrator.

CONNECTION INTERFACE

1. Connection thru the serial port.

Communication Protocol

Item	Information
Baud rate	19200/4800/38400/9600 bps
Data length	8 bits
Parity bit	No parity
Stop bit	1 bit
Flow control	None
Communications procedure	Full duplex

2. Connection via network

Communication Protocol (Connection via LAN)

Item	Information
Communication speed	Set automatically (10/100 Mbps)
Supported standard	IEEE802.3 (10BASE-T) IEEE802.3u (100BASE-TX, Auto-Negotiation)

Use the TCP port number 7142 for transmitting and receiving command.

PARAMETERS FOR THIS DEVICE

Input command

Input terminal	Response	Parameter
Computer	Computer	computer1, computer, rgb, rgb1, vga, vga1
HDMI1	HDMI1	hdmi1
HDMI2	HDMI2	hdmi2
Video	Video	video
USB-A	USB-A	usb-a
LAN	LAN	lan

Status command

Response	Error Status
error:temp	Temperature error
error:fan	Fan trouble
error:light	Light source trouble
error:system	System trouble

7 Troubleshooting Check List

Before contacting your dealer or service personnel, check the following list to be sure repairs are needed also by referring to the “Troubleshooting” section in your user’s manual. This checklist below will help us solve your problem more efficiently.

* Print this page and the next page for your check.

Frequency of occurrence always sometimes (How often? _____) other (_____)

Power

- No power (POWER indicator does not light blue) See also “Status Indicator (STATUS)”.
- Power cord’s plug is fully inserted into the wall outlet.
- Main power switch is pressed to the ON position.
- Lamp cover is installed correctly.
- Lamp Hours Used (lamp operation hours) was cleared after lamp replacement.
- No power even though you press and hold the POWER button.
- Shut down during operation.
 - Power cord’s plug is fully inserted into the wall outlet.
 - Lamp cover is installed correctly.
 - [Timer] is turned off.

Video and Audio

- No image is displayed from your PC or video equipment to the projector.
 - Still no image even though you connect the projector to the PC first, then start the PC.
 - Enabling your notebook PC’s signal output to the projector.
 - *A combination of function keys will enable/disable the external display. Usually, the combination of the “Fn” key along with one of the 12 function keys turns the external display on or off.*
 - No image (blue or black background, no display).
 - Still no image even though you press the AUTO ADJUST button.
 - Signal cable’s plug is fully inserted into the input terminal.
 - A message appears on the screen. (_____)
 - The source connected to the projector is active and available.
 - Still no image even though you adjust the brightness and/or the contrast.
 - Input source’s resolution and frequency are supported by the projector.
- Image is too dark.
 - Remains unchanged even though you adjust the brightness and/or the contrast.
- Image is distorted.
 - Image appears to be trapezoidal (unchanged even though you carry out the [KEYSTONE] adjustment).
- Parts of the image are lost.
 - Still unchanged even though you press the AUTO ADJUST button.
- Image is shifted in the vertical or horizontal direction.
 - Horizontal and vertical positions are correctly adjusted on a computer signal.
 - Input source’s resolution and frequency are supported by the projector.
 - Some pixels are lost.
- Image is flickering.
 - Still unchanged even though you press the AUTO ADJUST button.
 - Image shows flickering or color drift on a computer signal.
 - Still unchanged even though you change [High altitude] to [Off].
- Image appears blurry or out of focus.
 - Still unchanged even though you checked the signal’s resolution on PC and changed it to projector’s native resolution.
 - Still unchanged even though you adjusted the focus.
- No sound.
 - Audio cable is correctly connected to the audio input of the projector.
 - Still unchanged even though you adjusted the volume level.
 - AUDIO OUT is connected to your audio equipment (only models with the AUDIO OUT terminal).

Other

- Remote control does not work.
 - No obstacles between the sensor of the projector and the remote control.
 - Projector is placed near a fluorescent light that can disturb the infrared remote controls.
 - Batteries are new and are not reversed in installation.
- Buttons on the projector cabinet do not work
 - [Key lock] is not turned on or is disabled in the menu.
 - Still unchanged even though you press and hold the INPUT button for a minimum of 10 seconds.

In the space below please describe your problem in detail.

Information on application and environment where your projector is used

Projector

Model number:
 Serial No.:
 Date of purchase:
 Lamp operating time (hours):
 Eco Mode: OFF AUTO ECO
 NORMAL ECO

Information on input signal:
 Horizontal synch frequency [] kHz
 Vertical synch frequency [] Hz
 Synch polarity H (+) (-)
 V (+) (-)
 Synch type Separate Composite
 Sync on Green

Indicator Message:
 POWER
 Blinks in Blue Green Orange Red
 [] cycles
 Lights in Blue Green Orange Red
 STATUS
 Blinks in Blue Green Orange Red
 [] cycles
 Lights in Blue Green Orange Red
 LAMP
 Blinks in Blue Green Orange Red
 [] cycles
 Lights in Blue Green Orange Red
 Remote control model number:

Signal cable

Dukane standard or other manufacturer's cable?
 Model number: Length: inch/m
 Distribution amplifier
 Model number:
 Switcher
 Model number:
 Adapter
 Model number:

Installation environment

Screen size: inch
 Screen type: White matte Beads Polarization
 Wide angle High contrast
 Throw distance: feet/inch/m
 Orientation: Ceiling mount Desktop
 Power outlet connection:
 Connected directly to wall outlet
 Connected to power cord extender or other (the number of connected equipment _____)
 Connected to a power cord reel or other (the number of connected equipment _____)

Computer

Manufacturer:
 Model number:
 Notebook PC / Desktop
 Native resolution:
 Refresh rate:
 Video adapter:
 Other:

Video equipment

VCR, DVD player, Video camera, Video game or other
 Manufacturer:
 Model number:

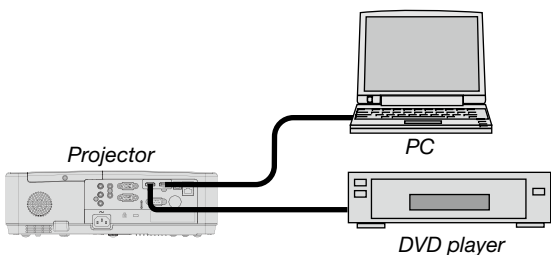

DUKANE