



Scan for full manual

VS-622DT Quick Start Guide

This guide helps you install and use your VS-622DT for the first time.

Go to www.kramerav.com/downloads/VS-622DT to download the latest user manual and check if firmware upgrades are available.

Step 1: Check what's in the box

- ✓ VS-622DT 6x2 HDMI / HDBT Audio Matrix Switcher
- ✓ 1 Quick start guide
- ✓ 1 Set of rack ears
- ✓ 1 Power cord
- ✓ 4 Rubber feet

Step 2: Get to know your VS-622DT

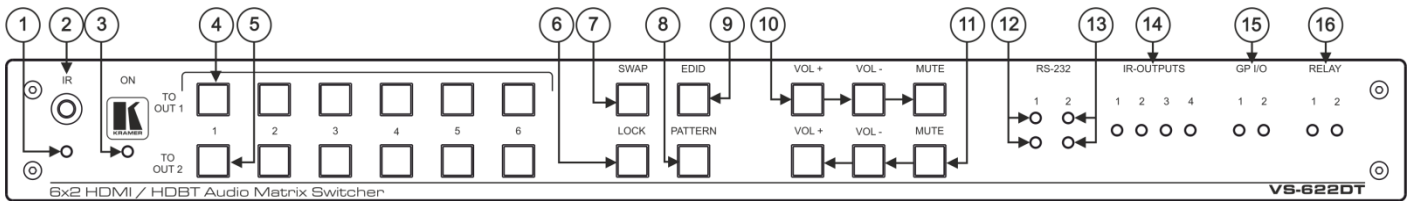

#	Feature	Function
1	IR LED	Lights red when the unit accepts IR remote commands.
2	IR Receiver	Receives signals from the remote control transmitter.
3	ON LED	Lights when the unit is powered.
4	TO OUT 1	Press to select an input to switch to OUT 1 (from 1 to 6).
5	TO OUT 2	Press to select an input to switch to OUT 2 (from 1 to 6).
6	LOCK Button	Press to lock the front panel buttons.
7	SWAP Button	Press to swap between audio outputs.
8	PATTERN Button	Press to activate the test pattern generator. When the generator is active, press one of the input buttons to select a test pattern.
9	EDID Button	Press to capture the EDID.
10	Output 1 Audio Buttons	VOL +: Increase output 1 volume. VOL -: Decrease output 1 volume. MUTE: Mute output 1 audio signal.
11	Output 2 Audio Buttons	VOL +: Increase output 2 volume. VOL -: Decrease output 2 volume. MUTE: Mute output 1 audio signal.
12	HDBT RS-232 LEDs	Indicates data transmission from a controller to a device connected to the transmitter via HDBT OUT 1: TX 1: Lights green when data is transmitted via HDBT OUT 1. RX 1: Lights red when data is received on HDBT OUT 1.
13	EXTERNAL (Controller) LEDs	Indicates data transmission via the RS-232 port (item 29) to the VS-622DT: TX 2: Lights green when data is transmitted on the RS-232 port. RX 2: Lights red when data is received on the RS-232 port.
14	IR OUTPUT LEDs (1 to 4)	Lights green when the relevant IR port transmits data.
15	GPI/O LEDs (1 to 2)	Lights green when the port is triggered.
16	RELAY LEDs (1 to 2)	Lights green when the relay is closed.



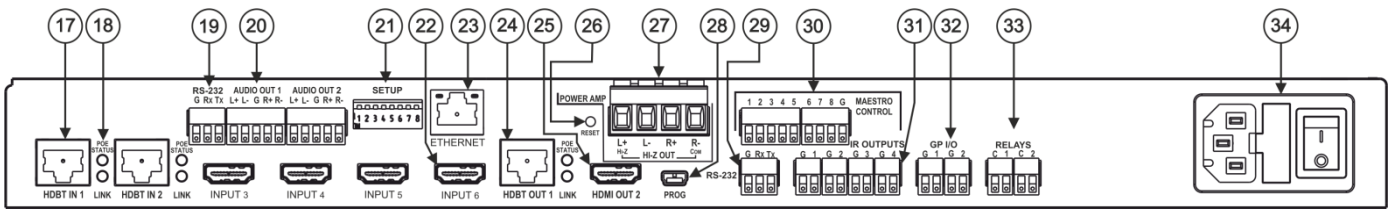

#	Feature	Function
17	HDBT IN 1 RJ-45 Connectors (1 to 2)	Connect to an HDBT transmitter (for example, TP-580Txr).
18	POE STATUS and LINK LEDs (for HDBT IN 1 to 2 and HDBT OUT 1)	Light when PoE is available and a link is established.
19	Control RS-232 3-pin Terminal Block	Connect to the serial controller to control the device.
20	AUDIO OUT Balanced Stereo Audio 5-pin Terminal Block Connectors (1 to 2)	Connect to an analog audio acceptor.
21	SETUP DIP-switches	Used to set the device behavior.
22	INPUT HDMI Connectors (3 to 6)	Connect to HDMI source (from 1 to 8).
23	ETHERNET RJ-45 Connector	Connect to a remote network controller via a LAN.
24	HDBT OUT1 RJ-45 Connector	Connect to an HDBT receiver (for example, TP-580Rxr)
25	HDMI OUT 2 Connector	Connect to an HDMI acceptor.
26	RESET Switch	Press and hold while powering on the device to reset to factory default parameters.
27	Hi-Z OUT Terminal Block Connectors	Lo-Z – connect stereo output to Lo-Z speakers: L+ and L- to the left speaker; R+R- to the right speaker. Hi-Z (70V or 100V) – connect Hi-Z and COM to mono Hi-Z speakers.
28	PROG Mini USB Connector	Connect to a PC to perform firmware upgrade.
29	RS-232 (G, Rx, Tx) Terminal Block Connector	Connect to an RS-232 controlled device.
30	MAESTRO CONTROL 9-pin Terminal Block Connectors	Connect to configurable buttons (configured via the Automation page), such as the RC-21TB .
31	IR OUTPUT 2-pin Terminal Block Connectors (1 to 4)	Connect to IR blasters/emitters using cables up to 80m (260ft) long.
32	GPI/O 2-pin Terminal Block Connectors (1 to 2)	Connect to controllable sensors or devices (for example, motion sensors). This port can be configured as a digital input, digital output, or analog input.
33	RELAY 2-pin Terminal Block Connectors (1 to 2)	Connect to a relay controllable device, (for example, a motorized projection screen).
34	Mains Power Connector, Fuse, and Switch	Connect to the mains supply.

Step 3: Install VS-622DT

Install **VS-622DT** using one of the following methods:

- Remove the three screws from each side of the unit, reinsert those screws through the rack ears and mount on a 19" rack.
- Attach the rubber feet and place the unit on a flat surface.

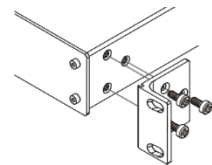

Step 4: Connect the inputs and outputs

Always switch OFF the power on each device before connecting it to your **VS-622DT**. For best results, we recommend that you always use Kramer high-performance cables to connect AV equipment to the **VS-622DT**.

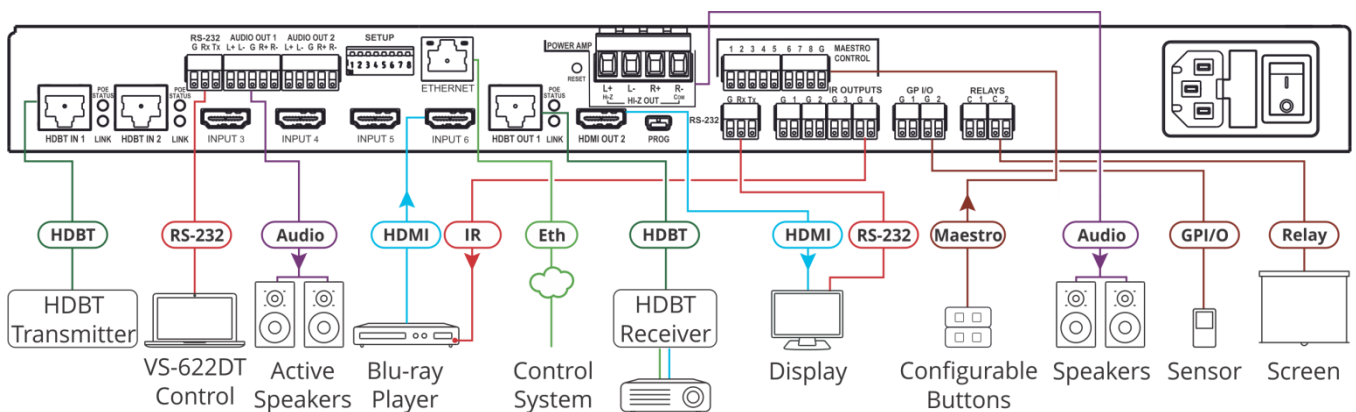

RJ-45 Pinout:

For the Ethernet connector, see the wiring diagram below:

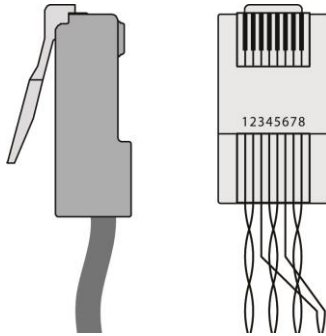

PIN EIA /TIA 568B	
PIN	Wire Color
1	Orange / White
2	Orange
3	Green / White
4	Blue
5	Blue / White
6	Green
7	Brown / White
8	Brown

For optimum range and performance use the recommended Kramer cables available at www.kramerav.com/product/VS-622DT.

Audio output pinout:

To a balanced stereo audio acceptor:

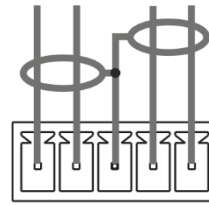

L+ L- G R+ R-

To an unbalanced stereo audio acceptor:

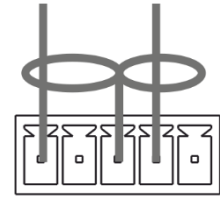

L+ L- G R+ R-

DIP-switch setup

A switch that is down is on; a switch that is up is off. By default, all the switches are up (off).

#	Feature	Description
1	HDCP support on inputs	On (down)—Disable HDCP support on all inputs. Off (up)—Enable HDCP support which is defined by P3000 commands.
2	Video mode switching Output 1	On (down)—Auto. Off (up)—Manual.
3	Last connected/Priority mode Output 1	When DIP-switch 2 is set to Auto (ON): On (down)—Enable Last Connected mode. Off (up)—Enable Priority mode where the priority of each input is defined by the input number, (1 is the highest priority).
4	Video mode switching Output 2	On (down)—Auto. Off—Manual.
5	Last connected/Priority mode Output 2	When DIP-switch 4 is set to Auto (ON): On (down)—Enable Last-connected mode. Off (up)—Enable Priority mode where the priority of each input is defined by the input number, (1 is the highest priority).
6	N/A	N/A
7	Range mode for HDBT IN 1	On (down) – HDBaseT Ultra-long range (provides increased range at a reduced bandwidth). Off (up) – Normal range (default).
8	Range mode for HDBT IN 2	On (down) – HDBaseT Ultra-long range (provides increased range at a reduced bandwidth). Off (up) – Normal range (default).

SETUP

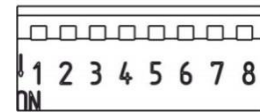

Step 5: Connect the power

Connect the power cord to **VS-622DT** and plug it into the mains electricity.

Safety Instructions



- Caution:** There are no operator serviceable parts inside the unit.
 - Warning:** Use only the power cord that is supplied with the unit.
 - Warning:** Do not open the unit. High voltages can cause electrical shock! Servicing by qualified personnel only.
 - Warning:** Disconnect the power and unplug the unit from the wall before installing.
- See www.KramerAV.com for updated safety information.

Step 6: Operate the VS-622DT

Web pages:

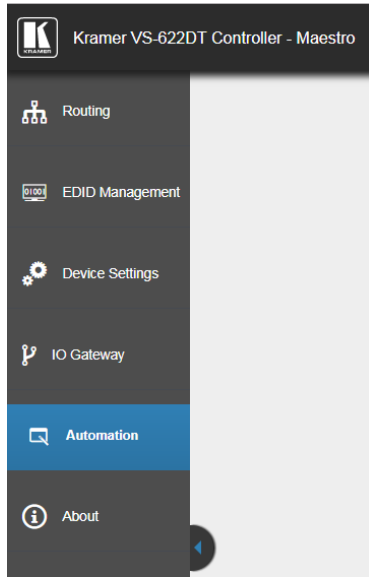

RS-232 and Ethernet:

RS-232/Ethernet			
Baud Rate:	115,200	Parity:	None
Data Bits:	8	Command Format:	ASCII Protocol 3000
Stop Bits:	1		
Example (Route input 1 to output 1):			#VID 1>1<cr>
Ethernet Parameters			
IP Address:	192.168.1.39	Default UDP Port #:	50000
Subnet Mask:	255.255.0.0		
Default Gateway:	192.168.0.1		
Full Factory Reset			
OSD:	Front panel buttons: power off the device, press and hold the RESET button for 3 seconds while powering the device, and then release.		
Protocol 3000:	"#FACTORY" command followed by #RESET command.		
Web Pages:	In the Device Settings page, General tab, click Factory reset.		

Technical Specifications

Inputs	2 HDBT	On female RJ-45 connectors	
	4 HDMI	On female HDMI connectors	
Outputs	1 HDBT	On a female RJ-45 connector	
	1 HDMI	On a female HDMI connector	
	2 Stereo Balanced Audio	On 5-pin terminal block connectors	
	1 Stereo or 1 Mono Speaker	On a 4-pin large terminal block	
Ports	1 Ethernet	On an RJ-45 female connector	
	2 RS-232	On 3-pin terminal blocks	
	1 USB	On a mini USB connector	
	4 IR	On 2-pin terminal block connectors	
	2 GPI/O	On 2-pin terminal block connectors	
	2 Relays	On 2-pin terminal block connectors	
Video	Max Resolution	Up to 4K@60Hz UHD (4:2:0)	
	Compliance	HDMI 1.4 and HDCP 1.4	
Reach	Extended	Up to 130m (430ft)	
Controls	Front Panel	Input selection buttons, swap, EDID, lock and audio control buttons	
		Power, RS-232, IR, GPI/O and relay indication LEDs	
	Remote	RS-232	
		Ethernet	
Power	Consumption	Web pages	
		IR remote control transmitter	
Environmental Conditions	Fan Ventilation	100-240V AC, 210VA max.	
		Operating Temperature	0° to +40°C (32° to 104°F)
		Storage Temperature	-40° to +70°C (-40° to 158°F)
Regulatory Compliance	Humidity	10% to 90%, RHL non-condensing	
		Safety	CE
Enclosure	Type	Environmental	RoHs, WEEE
		Size	19", 1U
General	Type	Aluminum	
		Net Dimensions (W, D, H)	43.64cm x 23.7cm x 4.36cm (17.18" x 9.3" x 1.72")
		Shipping Dimensions (W, D, H)	52.5cm x 33cm x 10.7cm (20.7" x 13" x 4.21")
		Net Weight	2.6kg (5.7lbs) approx.
Accessories	Included	Shipping Weight	3.7kg (8.2lbs) approx.
			Power cord