

KRAMER



USER MANUAL

MODEL:

VS-62DT

6x2 UHD Matrix Switcher

HDMI™ to HDMI & HDBaseT with PoE



Scan for full manual

VS-62DT Quick Start Guide

This guide helps you install and use your **VS-62DT** for the first time.

Go to www.kramerav.com/downloads/VS-62DT to download the latest user manual and check if firmware upgrades are available.

Step 1: Check what's in the box

- VS-62DT** 6x2 UHD Matrix Switcher
- 4 Rubber feet
- IR remote control transmitter with batteries
- 1 Power supply (48V DC)
- 1 Quick start guide

Step 2: Get to know your VS-62DT

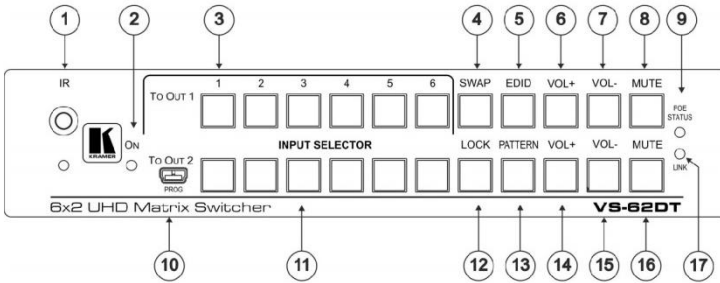

#	Feature	Function
1	IR Sensor & LED	Signal receiver for the infrared remote control transmitter. LED lights yellow
2	ON LED	Lights when the unit is powered on
3	INPUT SELECTOR TO OUT 1 (1 to 6)	Press one of the six inputs to switch it to output 1
4	SWAP Button	Press to swap output 1 and output 2 (analog audio only)
5	EDID Button	Press to capture the EDID
6	VOL+ Button	Press to increase the analog audio volume on output 1
7	VOL- Button	Press to decrease the analog audio volume on output 1
8	MUTE Button	Press to toggle muting of output 1 analog audio
9	POE STATUS LED	Lights when transmitting power over Ethernet to another device
10	PROG Mini USB Connector	Used for upgrading the firmware
11	INPUT SELECTOR TO OUT 2 (1 to 6)	Press one of the six inputs to switch it to output 2
12	LOCK Button	Press and hold to toggle locking and unlocking the front panel buttons
13	PATTERN Button	Press to toggle activation of the test pattern generator. When the generator is active, press one of the input buttons to select a test pattern
14	VOL+ Button	Press to increase the analog audio volume on output 2
15	VOL- Button	Press to decrease the analog audio volume on output 2
16	MUTE Button	Press to toggle muting of output 2 analog audio
17	LINK LED	Lights when there is activity on the HDBaseT connection

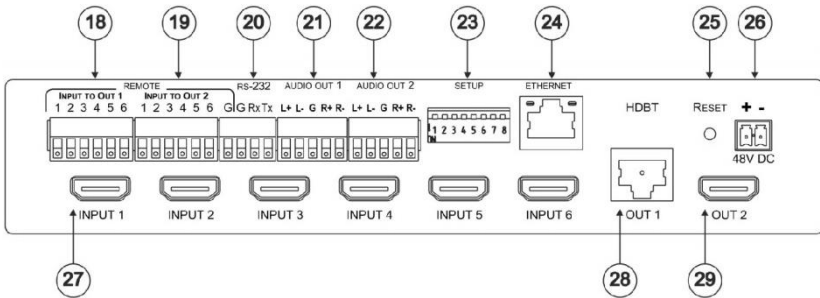

#	Feature	Function
18	REMOTE INPUT TO OUT 1 Terminal Block	Connects to external contact closure input switches
19	REMOTE INPUT TO OUT 2 Terminal Block	Connects to external contact closure input switches
20	RS-232 Terminal Block	Connects to a local RS-232 source
21	AUDIO OUT 1 Terminal Block	Connects to a balanced stereo audio acceptor
22	AUDIO OUT 2 Terminal Block	Connects to a balanced stereo audio acceptor
23	SETUP DIP-Switches	Sets the device configuration (see Step 7)
24	ETHERNET RJ-45 Connector	Connects to a network for control
25	RESET Button	Press while power-cycling the device to reset to factory default parameters
26	48V DC Connector	Connects to a power supply for the unit
27	INPUT 1 to 6 HDMI Connectors	Connect to up to 6 HDMI sources
28	HDBT OUT 1 R-J45 Connector	Connects to an HDBaseT TP line
29	OUT 2 HDMI Connector	Connects to an HDMI acceptor

Step 3: Install the VS-62DT

Attach the rubber feet and place on a table or mount the **VS-62DT** in a rack (using an optional **RK-1** rack mount).

Step 4: Connect the inputs and outputs

Always switch OFF the power on each device before connecting it to your **VS-62DT**. For best results, we recommend that you always use Kramer high-performance cables to connect AV equipment to the **VS-62DT**.

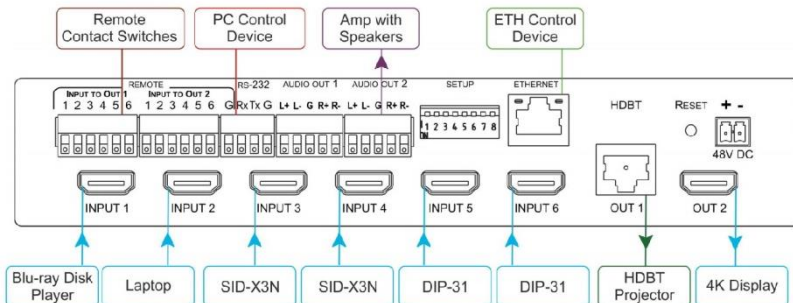

Connect the audio output:

To a balanced stereo audio acceptor:

L+ L- G R+ R-

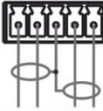

To a unbalanced stereo audio acceptor:

L+ L- G R+ R-

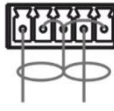

Step 5: Connect the power

Connect the 48V DC power adapter to the VS-62DT and plug it into the mains electricity.

Safety instructions



- Caution:** There are no operator serviceable parts inside the unit.
Warning: Use only the Kramer Electronics power supply that is provided with the unit.
Warning: Disconnect the power and unplug the unit from the wall before installing.
See www.kramerAV.com for updated safety information.

Step 6: Acquiring an EDID

To copy the EDID from an Output to one or more Inputs:

- Press the EDID button to enter the EDID setting mode. The EDID button lights.
- From the To OUT 1 (top) row, press each of the Inputs to which you want to copy the EDID from Output 1. Each selected Input LED lights.
- From the To OUT 2 (bottom) row, press each of the Inputs into which you want to copy the EDID from Output 2. Each selected Input LED lights.
- Press the EDID button. The button no longer lights and the EDID changes are saved.

To copy the default EDID to one or more Inputs:

- Press the EDID button to enter the EDID setting mode. The EDID button lights.
- For each Input to which you want to copy the default EDID, press both the To OUT 1 and To OUT 2 buttons simultaneously. Both top row and bottom row Input LEDs light.
- Press the EDID button. The button no longer lights and the EDID changes are saved.

Step 7: Set the DIP-switches

Use the DIP-switches to set the device configuration

#	Feature	Description
1	HDCP support on inputs	On (down)—Disable HDCP support on all inputs Off (up)—Enable HDCP support which is defined by P3000 commands
2	Video mode switching Output 1	On (down)—Auto Off (up)—Manual
3	Last connected/Priority mode Output 1	When DIP-switch 2 is set to Auto (ON): On (down)—Enable Last Connected mode Off (up)—Enable Priority mode where the priority of each input is defined by the input number, (1 is the highest priority)
4	Video mode switching Output 2	On (down)—Auto Off (up)—Manual
5	Last connected/Priority mode Output 2	When DIP-switch 4 is set to Auto (ON): On (down)—Enable Last-connected mode Off (up)—Enable Priority mode where the priority of each input is defined by the input number, (1 is the highest priority)
6	N/A	N/A
7	N/A	N/A
8	N/A	N/A

SETUP

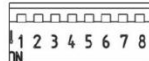

Step 8: Operate via the front panel buttons and via the:

IR remote controller:



Web pages:

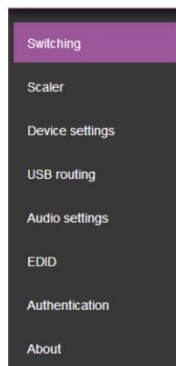

RS-232 and Ethernet:

Default RS-232 Parameters			
Baud Rate:	115,200 (9600)	Parity:	None
Data Bits:	8	Command Format:	ASCII
Stop Bits:	1		
Example (Route the video from the HDMI3 input to the HDMI OUT2 port):	#ROUTE 1,2,3<cr>		
TCP/IP Parameters			
IP Address:	192.168.1.39	Default UDP Port #:	50000
Subnet mask:	255.255.255.000	Maximum combined TCP and UDP Ports:	20
Default gateway:	192.168.1.254		

Step 9: Control peripheral devices via IR remote control:

You can use a remote control transmitter (that is used for controlling a peripheral device, for example, a DVD player) to send commands (to the A/V equipment) from to any of the transmitters /receivers connected to the HDBT connectors.

Contents

1	Introduction	1
2	Getting Started	2
2.1	Achieving the Best Performance	2
2.2	Safety Instructions	2
2.3	Recycling Kramer Products	3
3	Overview	4
4	Defining the VS-62DT 6x2 UHD Matrix Switcher	6
5	Connecting the VS-62DT 6x2 UHD Matrix Switcher	8
5.1	Connecting a Serial Controller to the VS-62DT via RS-232	9
5.2	Connecting to the VS-62DT via Ethernet	9
5.3	Connecting the Remote Contact-Closure Switches	12
6	Principles of Operation	14
6.1	Automatic Signal Detection	14
6.2	Input Switching Modes	14
6.3	EDID Operation	15
6.4	Step-in Functionality	15
7	Operating the VS-62DT 6x2 UHD Matrix Switcher	16
7.1	Switching an Input to an Output	16
7.2	Acquiring an EDID from an Output	16
7.3	Controlling Analog Audio	17
7.4	Locking and Unlocking the Front Panel Buttons	18
7.5	Generating a Test Pattern	19
8	Configuring and Maintaining the VS-62DT	20
8.1	Setting the DIP-switches	20
8.2	Resetting the VS-62DT to Factory Default Settings	21
8.3	Upgrading the Firmware	21
9	Operating the VS-62DT Remotely via the Web Pages	22
9.1	Accessing VS-62DT Web Pages	22
9.2	Selecting Input Signals	24
9.3	Adjusting Analog Audio Output	28
9.4	Managing the EDID	29
9.5	Setting Authentication	32
9.6	Setting Device Configurations	32
9.7	Upgrading the Firmware	35
9.8	About Kramer	36
10	Wiring the Twisted Pair RJ-45 Connectors	37
11	Technical Specifications	38
12	Default Communication Parameters	39
13	Default EDID	40
14	Protocol 3000	42
14.1	Understanding Protocol 3000	43
14.2	Kramer Protocol 3000 Syntax	44
15	Kramer Protocol 3000 Commands	46
15.1	System Commands - Mandatory	47
15.2	System Commands	52
15.3	Switching/Routing Commands	59

15.4	Communication Commands	62
15.5	EDID Handling Commands	67
15.6	Step-In Commands	68
15.7	Audio Commands	69
15.8	Video Commands	72

Figures

Figure 1:	VS-62DT 6x2 UHD Matrix Switcher	6
Figure 2:	VS-62DT 6x2 UHD Matrix Switcher	7
Figure 3:	Connecting the VS-62DT 6x2 UHD Matrix Switcher	9
Figure 4:	Local Area Connection Properties Window	11
Figure 5:	Internet Protocol Version 4 Properties Window	11
Figure 6:	Internet Protocol Properties Window	12
Figure 7:	Remote Contact-closure Switch Connections	13
Figure 8:	Available Test Patterns	19
Figure 9:	Entering Logon Credentials	23
Figure 10:	Web Cache Window	23
Figure 11:	Opening Web Page	24
Figure 12:	Video Switching Page	25
Figure 13:	Remote Device Control Window	26
Figure 14:	Test Pattern Tab	27
Figure 15:	EDID Management Page	29
Figure 16:	EDID Bytemap	31
Figure 17:	Authentication Page	32
Figure 18:	Device Settings Page	33
Figure 19:	Firmware Upgrade	35
Figure 20:	About Kramer	36
Figure 21:	TP Pinout Wiring	37

1 Introduction

Welcome to Kramer Electronics! Since 1981, Kramer Electronics has been providing a world of unique, creative, and affordable solutions to the vast range of problems that confront video, audio, presentation, and broadcasting professionals on a daily basis. In recent years, we have redesigned and upgraded most of our line, making the best even better!

Our 1,000-plus different models now appear in 14 groups that are clearly defined by function: GROUP 1: Distribution Amplifiers; GROUP 2: Switchers and Routers; GROUP 3: Control Systems; GROUP 4: Format/Standards Converters; GROUP 5: Range Extenders and Repeaters; GROUP 6: Specialty AV Products; GROUP 7: Scan Converters and Scalers; GROUP 8: Cables and Connectors; GROUP 9: Room Connectivity; GROUP 10: Accessories and Rack Adapters; GROUP 11: Sierra Video Products; GROUP 12: Digital Signage; GROUP 13: Audio; and GROUP 14: Collaboration.

Congratulations on purchasing your Kramer **VS-62DT** *6x2 UHD Matrix Switcher* which is ideal for the following typical applications:

- Conference rooms
- Education
- Hospitality

2 Getting Started

We recommend that you:

- Unpack the equipment carefully and save the original box and packaging materials for possible future shipment
- Review the contents of this user manual



Go to www.kramerav.com/downloads/VS-62DT to check for up-to-date user manuals, application programs, and to check if firmware upgrades are available (where appropriate).

2.1 Achieving the Best Performance

To achieve the best performance:

- For optimum range and performance, use the recommended Kramer cables available at www.kramerav.com/product/VS-62DT
- Do not secure the cables in tight bundles or roll the slack into tight coils
- Avoid interference from neighboring electrical appliances that may adversely influence signal quality
- Position your **VS-62DT** away from moisture, excessive sunlight and dust



This equipment is to be used only inside a building. It may only be connected to other equipment that is installed inside a building

2.2 Safety Instructions



Caution: There are no operator serviceable parts inside the unit

Warning: Use only the Kramer Electronics power supply that is provided with the unit

Warning: Disconnect the power and unplug the unit from the wall before installing

2.3 Recycling Kramer Products

The Waste Electrical and Electronic Equipment (WEEE) Directive 2002/96/EC aims to reduce the amount of WEEE sent for disposal to landfill or incineration by requiring it to be collected and recycled. To comply with the WEEE Directive, Kramer Electronics has made arrangements with the European Advanced Recycling Network (EARN) and will cover any costs of treatment, recycling and recovery of waste Kramer Electronics branded equipment on arrival at the EARN facility. For details of Kramer's recycling arrangements in your particular country go to our recycling pages at www.kramerav.com/support/recycling/.

3 Overview

The **VS-62DT** is a 6x2 4K@60Hz (4:2:0) HDMI/HDBaseT matrix switcher with HDMI and HDBaseT output transmitters that provide long-reach video and audio transmission. It supports resolutions of up to 4K@60Hz (4:2:0) and WUXGA. The matrix is a PoE provider that provides power over Ethernet to compatible PoE receivers.

The **VS-62DT** features:

- Up to 8.91Gbps data rate (2.97Gbps per graphics channel)
- Maximum resolution of up to 4K@60Hz UHD (4:2:0).
- Long-reach signal extension – Up to 70m (230ft) at 1080p or 40m (130ft) at 4K60 (4:2:0)
- Support for HDCP 1.4 (High Definition Digital Content Protection)
- HDMI 1.4 Support – 3D, Deep Color, x.v.Color™, Lip Sync, Dolby® TrueHD, Dolby Digital Plus, DTS-HD®, and 7.1 multi-channel audio
- Six HDMI inputs that can be routed to an HDMI or HDBT output
- Supply of Power-over-Ethernet to compatible PoE receivers
- Per input EDID capture that copies and stores the EDID from a display device
- Programmable step-in functionality when used in conjunction with compatible step-in devices, such as the **SID-X3N** and **DIP-31** (using an HDMI cable that supports HEC, the HDMI Ethernet Channel)
- True video clock detection
- Advanced auto AV switching modes (last connected and priority switching)
- Non-volatile EDID storage
- Kramer reClocking™ & Equalization Technology that rebuilds the digital signal to travel longer distances
- A lock button to prevent unwanted tampering with the buttons on the front panel
- Internal pattern generator

- Support for Kramer Protocol 3000
- Static or dynamic DHCP IP addressing
- Flexible control options including front panel buttons, IR remote (included), RS-232, Ethernet, contact closure buttons, embedded Web server and step-in.
- Mini-USB port for upgrading firmware

4 Defining the VS-62DT 6x2 UHD Matrix Switcher

This section defines the **VS-62DT**.

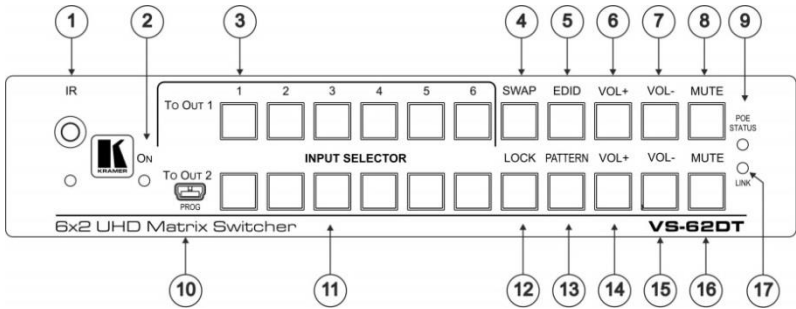

Figure 1: VS-62DT 6x2 UHD Matrix Switcher

#	Feature	Function	
1	IR Sensor & LED	Signal receiver for the infrared remote control transmitter. LED lights yellow	
2	ON LED	Lights when the unit is powered on	
3	INPUT SELECTOR (1 to 6)	Press one of the six inputs to switch it to output 1	
4		SWAP Button	Press to swap output 1 and output 2
5		EDID Button	Press to capture the EDID (see Section 6.3)
6		VOL+ Button	Press to increase the volume on output 1
7		VOL- Button	Press to decrease the volume on output 1
8		MUTE Button	Press to toggle muting of output 1 audio
9	POE STATUS LED	Lights when transmitting power over Ethernet to another device	
10	PROG Mini USB Connector	Used for upgrading the firmware	
11	INPUT SELECTOR (1 to 6)	Press one of the six inputs to switch it to output 2	
12		LOCK Button	Press and hold to toggle locking and unlocking the front panel buttons (see Section 7.4)
13		PATTERN Button	Press to toggle activation of the test pattern generator. When the generator is active, press one of the input buttons to select a test pattern
14		VOL+ Button	Press to increase the volume on output 2
15		VOL- Button	Press to decrease the volume on output 2
16		MUTE Button	Press to toggle muting of output 2 audio
17	LINK LED	Lights when there is activity on the Ethernet connection	

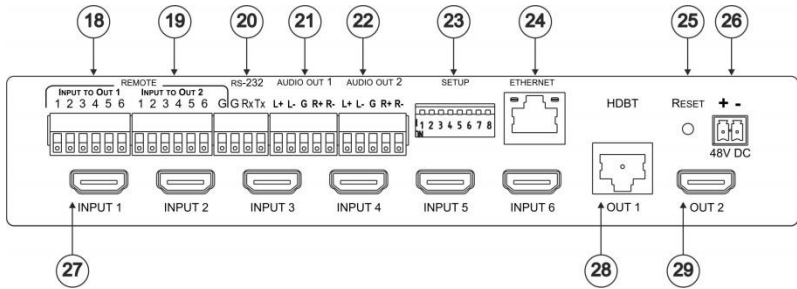

Figure 2: VS-62DT 6x2 UHD Matrix Switcher

#	Feature	Function
18	<i>REMOTE INPUT TO OUT 1</i> Terminal Block	Connects to external contact closure input switches
19	<i>REMOTE INPUT TO OUT 2</i> Terminal Block	Connects to external contact closure input switches
20	<i>RS-232</i> Terminal Block	Connects to a local RS-232 source
21	<i>AUDIO OUT 1</i> Terminal Block	Connects to a balanced stereo audio acceptor
22	<i>AUDIO OUT 2</i> Terminal Block	Connects to a balanced stereo audio acceptor
23	<i>SETUP</i> DIP-Switches	Set switches to configure the device (see Section 8.1)
24	<i>ETHERNET</i> RJ-45 Connector	Connects to a network for control
25	<i>RESET</i> Button	Press to reset the device or return to factory settings (see Section 8.2)
26	<i>48V DC</i> Connector	Connects to a power supply for the unit
27	<i>INPUT 1</i> to <i>6</i> HDMI Connectors	Connect to up to 6 HDMI sources
28	<i>HDBT OUT 1</i> RJ-45 Connector	Connects to an HDBT TP line
29	<i>OUT 2</i> HDMI Connector	Connects to an HDMI acceptor

5 Connecting the VS-62DT 6x2 UHD Matrix Switcher



Always switch off the power to each device before connecting it to your **VS-62DT**. After connecting your **VS-62DT**, connect its power and then switch on the power to each device.



You do not have to connect all the inputs and outputs, connect only those that are required.

To connect the **VS-62DT**, as illustrated in [Figure 3](#), do the following:

1. Connect up to six HDMI sources, (for example, a laptop, Blu-ray player, **SID-X3N** or **DIP-31**) to the HDMI In connectors.
2. Connect the HDBT OUT1 connector to an HDBT acceptor, (for example, an HDBT projector).
3. Connect the HDMI OUT2 connector to an HDMI acceptors, (for example, 2K or 4K display).
4. Connect the two balanced AUDIO OUT 5-pin terminal block connectors to up to two analog audio acceptors, (for example, audio amplifiers).
5. If required, connect a PC/controller to the RS-232 port (see [Section 5.1](#)) and/or the Ethernet port (see [Section 5.2](#)).
6. If required for remote switching, connect up to 6 contact closure switches per channel to their INPUT TO OUT terminal block connectors.
7. Connect the 48V DC power supply to the device and plug it into the mains electricity (not shown in [Figure 3](#)).
8. If required, acquire the EDID (see [Section 6.3](#)).

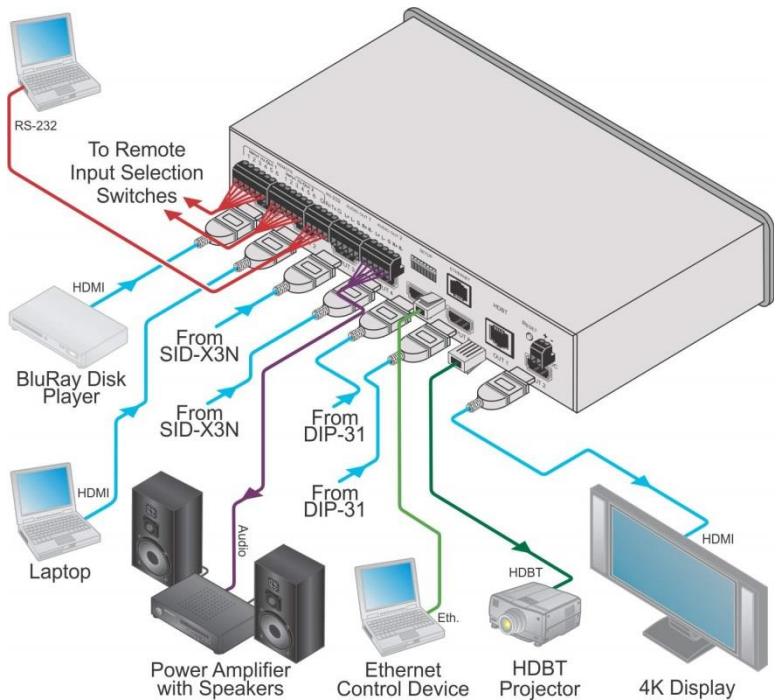

Figure 3: Connecting the VS-62DT 6x2 UHD Matrix Switcher

5.1 Connecting a Serial Controller to the VS-62DT via RS-232

To connect a serial controller to the VS-62DT:

From the RS-232 9-pin D-sub serial port on the serial controller connect:

- Pin 2 to the TX pin on the **VS-62DT** RS-232 terminal block
- Pin 3 to the RX pin on the **VS-62DT** RS-232 terminal block
- Pin 5 to the GND pin on the **VS-62DT** RS-232 terminal block

5.2 Connecting to the VS-62DT via Ethernet

You can connect to the **VS-62DT** via Ethernet using either of the following methods:

- Directly to the PC using a crossover cable (see [Section 5.2.1](#))

- Via a network hub, switch, or router, using a straight-through cable (see [Section 5.2.2](#))



Note: If you want to connect via a router and your IT system is based on IPv6, speak to your IT department for specific installation instructions.

5.2.1 Connecting the Ethernet Port Directly to a PC

You can connect the Ethernet port of the **VS-62DT** directly to the Ethernet port on your PC using a crossover cable with RJ-45 connectors.



This type of connection is recommended for identifying the **VS-62DT** with the factory configured default IP address.

After connecting the VS-62DT to the Ethernet port, configure your PC as follows:

1. Click **Start > Control Panel > Network and Sharing Center**.
2. Click **Change Adapter Settings**.
3. Highlight the network adapter you want to use to connect to the device and click **Change settings of this connection**.

The Local Area Connection Properties window for the selected network adapter appears as shown in [Figure 4](#).

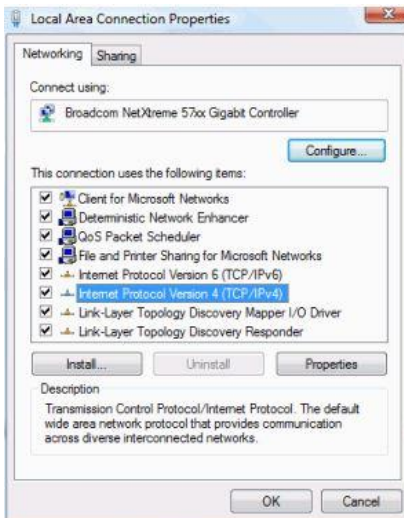

Figure 4: Local Area Connection Properties Window

4. Highlight **Internet Protocol Version 4 (TCP/IPv4)** by clicking on the item.
5. Click **Properties**.

The Internet Protocol Properties window appears as shown in [Figure 5](#).

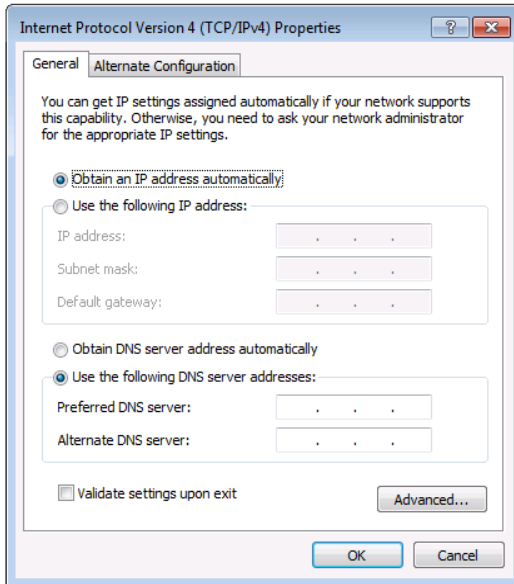

Figure 5: Internet Protocol Version 4 Properties Window

6. Select **Use the following IP Address** for static IP addressing and fill in the details as shown in [Figure 6](#).

For TCP/IPv4 you can use any IP address in the range 192.168.1.1 to 192.168.1.255 (excluding 192.168.1.39) that is provided by your IT department.

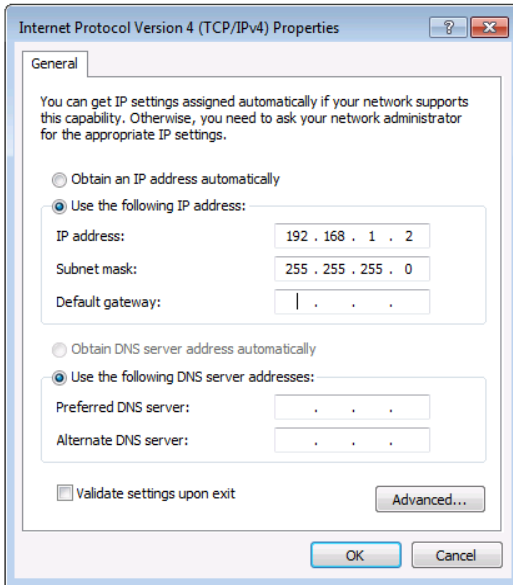

Figure 6: Internet Protocol Properties Window

7. Click **OK**.
8. Click **Close**.

5.2.2 Connecting the Ethernet Port via a Network Hub or Switch

You can connect the Ethernet port of the **VS-62DT** to the Ethernet port on a network hub or using a straight-through cable with RJ-45 connectors.

5.3 Connecting the Remote Contact-Closure Switches

You can connect up to six remote, contact-closure switches per output to control the **VS-62DT** remotely. These switches replicate the Input selection buttons on the front panel of the **VS-62DT**.

[Figure 7](#) illustrates the wiring of the switch connections to the terminal block.

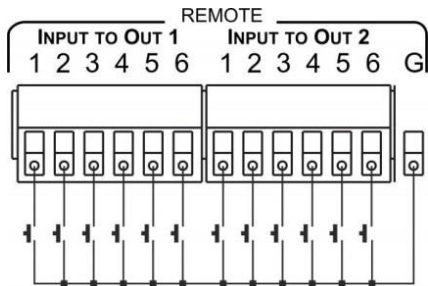

Figure 7: Remote Contact-closure Switch Connections

6 Principles of Operation

This section describes the operating theory of the **VS-62DT** and includes:

- Automatic signal detection (see [Section 6.1](#))
- Input switching modes (see [Section 6.2](#))
- EDID operation (see [Section 6.3](#))

6.1 Automatic Signal Detection

The **VS-62DT** can automatically detect the presence of a video signal on an input based on the presence of a video sync or clock signal.

6.2 Input Switching Modes

6.2.1 Manual Mode

In Manual switching mode, routing is performed according to the front panel button selection or according to the remote command selection.

6.2.2 Automatic Mode

Automatic switching can be performed in either of the following ways:

- **Input priority.** Upon detection of an active input, the input with the highest priority is automatically selected. Input priority is from input 1 (highest priority) to input 6 (lowest priority).
- **Last Connected.** The device automatically selects the most recently connected input. Should this source become inactive, the device automatically switches to the last connected input that was active. When turning the device on and more than one input is active, the input with the highest priority is selected.

If a manual selection is made when the device is in Automatic mode, the device enters Manual Override mode. The manually selected input remains selected as long as it is active. When a manually selected input becomes inactive, the device returns to Automatic mode.

6.3 EDID Operation

The **VS-62DT** has a default EDID (see [Section 13](#)) stored on all inputs. This EDID can be exchanged for either:

- A custom EDID which is uploaded to one or more inputs using Protocol 3000 commands (see [Section 14](#))
–OR–
- The EDID of a display device connected to an output by using either the front panel buttons (see [Section 3](#)), a Protocol 3000 command, or the Web pages

The EDID is non-volatile and the last valid EDID is used when the device is powered up.

6.4 Step-in Functionality

The **VS-62DT** can function as a step-in switcher when connected to a suitable HDMI transmitter, (for example, the **SID-X3N**), using the correct HDMI cable with HEC support.

Use the Web pages (see [Section 9.2.2](#)) to assign remote device button actions. The default button actions are shown in the following table. Up to three buttons can be active at the same time.

Command	Action
Echo	Allows a connected controller to be programmed to perform a variety of tasks triggered by the user buttons, such as, room control, (lights, screen, and so on)
Out1	Step in current input to Output 1
Out2	Step in current input to Output 2

7 Operating the VS-62DT 6x2 UHD Matrix Switcher

This section describes operating the **VS-62DT** and consists of:

- Switching an input to an output (see [Section 7.1](#))
- Acquiring an EDID from an output (see [Section 7.2](#))
- Controlling analog audio (see [Section 7.3](#))
- Locking and unlocking the front panel buttons (see [Section 7.4](#))
- Generating a test pattern (see [Section 7.5](#))

7.1 Switching an Input to an Output

To switch an input to an output, (for example, Input 5 to Output 2):

- Press the Input 5 button in the bottom Output (To OUT 2) row.
The LED lights red and Input 5 is switched to Output 2

To turn off audio and video simultaneously:

- Press and hold the currently selected input button.
The input button turns off and the audio and video are muted for the selected input.
- To turn on the audio and video, press this or any other input select button.

7.2 Acquiring an EDID from an Output

You can acquire the EDID from OUT 1 or OUT 2 and copy it to any or all of the six inputs to be stored in non-volatile memory. You can also reset any or all of the inputs to the default EDID.

To copy the EDID from an Output to one or more Inputs:

1. Press the EDID button to enter the EDID setting mode.
The EDID button lights.

Note: If there is no button activity for 10 seconds, the device automatically exits the EDID setting mode to normal operation, the EDID button no longer lights and any changes made are lost.

2. From the To OUT 1 (top) row, press each of the Inputs to which you want to copy the EDID from Output 1.
Each selected Input LED lights.
3. From the To OUT 2 (bottom) row, press each of the Inputs into which you want to copy the EDID from Output 2.
Each selected Input LED lights.
4. Press the EDID button.
The button no longer lights and the EDID changes are saved.

To copy the default EDID to one or more Inputs:

1. Press the EDID button to enter the EDID setting mode.
The EDID button lights.
2. For each Input to which you want to copy the default EDID, press both the To OUT 1 and To OUT 2 buttons simultaneously.
Both top row and bottom row Input LEDs light.
3. Press the EDID button.
The button no longer lights and the EDID changes are saved.

7.3 Controlling Analog Audio

Control analog audio using volume, mute and swap buttons.

To change the volume on a selected analog audio output:

- Press VOL+ to increase the volume.
- Press VOL- to decrease the volume.

To mute and unmute the analog audio of a selected output:

1. Press MUTE on the desired channel.
The MUTE button lights.
2. To unmute, press MUTE again. The analog audio plays.

To swap outputs:

1. To put analog Output 1 on analog Output 2 and vice versa, press SWAP.
The outputs change places and swap button lights.
2. To return to the initial state, press SWAP again.

7.4 Locking and Unlocking the Front Panel Buttons

To lock and unlock the front panel buttons:

1. Press and hold the Lock button.
The front panel buttons are locked and the button lights.
2. Press and hold the Lock button again.
The front panel buttons are unlocked and the button no longer lights.

7.5 Generating a Test Pattern

For diagnostic purposes, the **VS-62DT** can generate a number of test patterns on the outputs.

To generate a test pattern on the outputs:

1. Press the Function button.
The button lights.
2. Press any of the Input buttons to select a test pattern.
The selected test pattern is generated on the outputs.

To exit the test pattern generator:

- Press the lit Function button.
The test pattern generation ceases and the button no longer lights.

[Figure 8](#) shows the test patterns available.

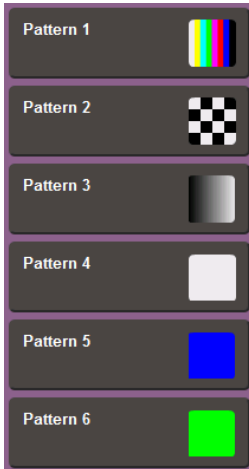

Figure 8: Available Test Patterns



All test pattern outputs are displayed in RGB 720x480/59Hz, 8-bit color resolution.

8 Configuring and Maintaining the VS-62DT

This section describes the configuration and maintenance of the **VS-62DT** and consists of:

- Setting the DIP-switches (see [Section 8.1](#))
- Resetting the device to factory default settings (see [Section 8.2](#))
- Upgrading the firmware (see [Section 8.3](#))

8.1 Setting the DIP-switches

The DIP-switches dictate the behavior of the **VS-62DT**.

All DIP-switches are off by default.

#	Feature	Description
1	HDCP support on inputs	On (down)—Disable HDCP support on all inputs Off (up)—Enable HDCP support which is defined by P3000 commands
2	Video mode switching Output 1	On (down)—Auto Off (up)—Manual
3	Last connected/Priority mode Output 1	When DIP-switch 2 is set to Auto (ON): On (down)—Enable Last Connected mode Off (up)—Enable Priority mode where the priority of each input is defined by the input number, (1 is the highest priority)
4	Video mode switching Output 2	On (down)—Auto Off—Manual
5	Last connected/Priority mode Output 2	When DIP-switch 4 is set to Auto (ON): On (down)—Enable Last-connected mode Off (up)—Enable Priority mode where the priority of each input is defined by the input number, (1 is the highest priority)
6	N/A	N/A
7	N/A	N/A
8	N/A	N/A

8.2 Resetting the VS-62DT to Factory Default Settings

To reset the device to factory default settings:

1. Power off the device.
2. Press and hold down the Reset button on the rear panel.
3. While holding down the Reset button, power on the device.
4. Wait a few seconds and release the button.
The device is reset to its factory settings.

8.3 Upgrading the Firmware

The **VS-62DT** can be upgraded via any of the following:

- Mini USB
- RS-232
- Ethernet
- Web page

For instructions on upgrading the firmware see “*K-Upload Software*”.

9 Operating the VS-62DT Remotely via the Web Pages

The **VS-62DT** can be operated remotely using the embedded Web pages. The Web pages are accessed using a Web browser and an Ethernet connection.

Before attempting to connect:

- Perform the procedures in [Section 5.2](#)
- Ensure that your browser is supported (see [Section 11](#))
- Ensure that JavaScript is enabled

9.1 Accessing VS-62DT Web Pages



In the event that a Web page does not update correctly, clear your Web browser's cache by pressing CTRL+F5.

To access the VS-62DT Web pages:

1. Open your Internet browser.
2. Type the IP number of the device in the address bar of your browser. The default IP address of the **VS-62DT** is 192.168.1.39



If authentication is enabled, the following window appears ([Figure 9](#)) and you must enter the valid username (**Admin**) and password (**Admin**) to access the Web pages.

3. Enter the User Name and Password.

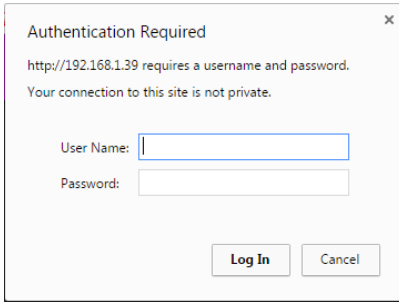

Figure 9: Entering Logon Credentials

Next, the Web Cache window appears.

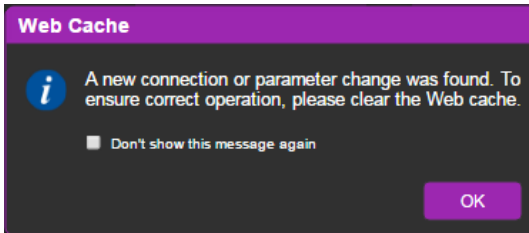

Figure 10: Web Cache Window

4. Clear the Web cache or check "Don't show this message again" and click **OK**.

The opening (Video Switching) Web page appears:

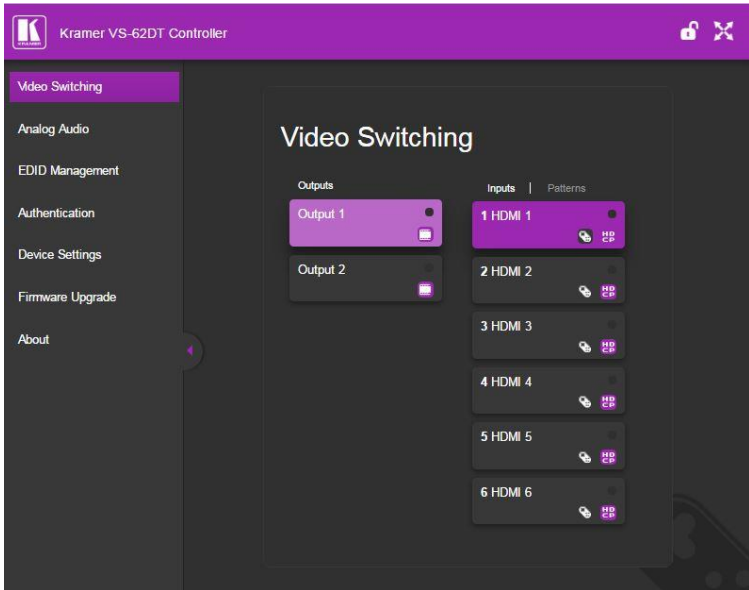



Figure 11: Opening Web Page

- To expand the left-hand side page panel, click the Reveal button ►.
- To hide the left-hand side page panel, click the Hide button ◀.
- To lock the page, click .
- To toggle in and out of full screen mode, click .

9.2 Selecting Input Signals

The Video Switching page enables you perform operational actions, such as, switching inputs/outputs and selecting HDCP support

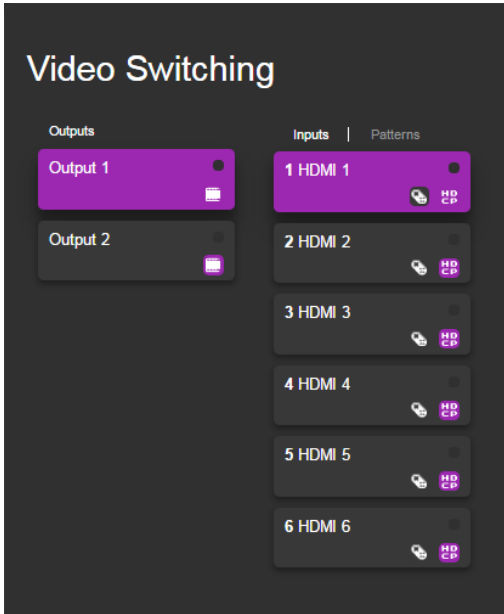





Figure 12: Video Switching Page

Item	Description
Output Buttons 1 and 2	2 Buttons for output selection, signal identification, and audio and video muting (see Section 9.2.1)
HDMI Input Buttons 1 to 6	6 Buttons for input selection, and port and signal identification (see Section 9.2.1)
Patterns	6 Buttons for video pattern generation (see Section 9.2.3)
 Video Mute Button	Click the button to mute the video
 Input/Output Active Indicator	Lights to indicate active input sources or active output acceptors
 Remote Device Control Button	Click the button to display the control window for the remote device connected to this Input (see Section 9.2.2)
 HDCP Content Button	Click the button to turn on or off the HDCP support for the input

9.2.1 Switching an Input to an Output

To switch an Input to an Output, (for example, Input 2 to Output 2):

1. Click on Output button 2.
The button changes color to purple and the Output is selected.
2. Click on Input button 2.
The button changes color to purple and the output is switched.

9.2.2 Controlling a Remote Transmitter

Compatible remote transmitters, (for example, the **SID-X3N**) that are connected to the **VS-62DT** can be controlled using the Web pages.

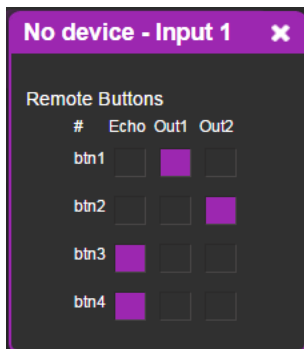

Figure 13: Remote Device Control Window

The **VS-62DT** enables programming the general purpose buttons on remote modules. The table shows the functionality defined for each button. The options are:

- Echo—allows a connected controller to be programmed to perform a variety of tasks triggered by the user buttons, such as, room control, (lights, screen, and so on)
- Out 1—step-in current input to output 1
- Out 2—step-in current input to output 2

Note: These settings are per input and remain valid even if the remote **SID-X3N** is exchanged for another **SID-X3N**.

Up to three of the Echo, Out 1 and Out 2 buttons can be active at the same time.

9.2.3 Using Test Patterns as Video Inputs

You can use one of six built-in, video test patterns as a video Input.

To select a test pattern as an Input for an Output:

1. Click **Patterns**.

The six test pattern buttons are shown.

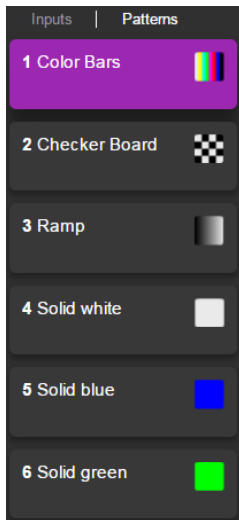

Figure 14: Test Pattern Tab



2. Click the required test pattern button.

The button changes color and the selected test pattern is switched to the Output.

9.3 Adjusting Analog Audio Output

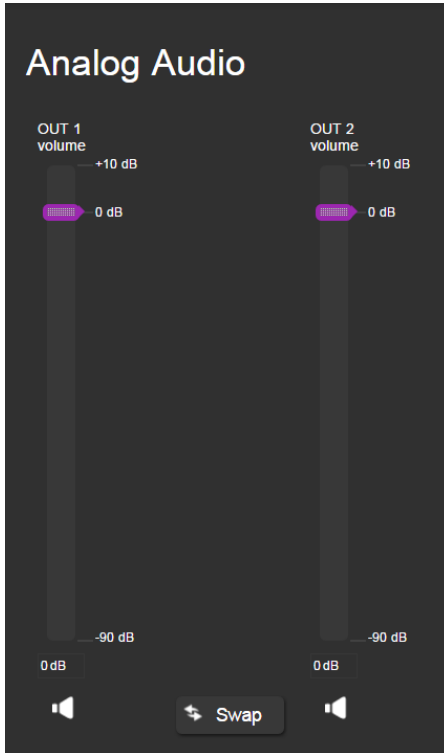
The Analog Audio page enables you to adjust output levels, mute or unmute the outputs and to swap outputs.



Item	Description
Out 1 and 2 Volume Sliders	The volume of each channel ranges from -90dB to +10dB. Slide the sliders up and down to adjust the volume level
 Mute/  Unmute Button	Click to mute the channel output. X appears on the icon and the output is muted. Click again to unmute and the red "x" disappears.
 Swap <i>Swap Button</i>	Click to toggle swapping output 1 to output 2 and output 2 to output 1 and vice versa.

9.4 Managing the EDID

The **VS-62DT** EDID page lets you copy EDID data to one or more Inputs from an:

- Output
- Input
- Default EDID
- EDID data file

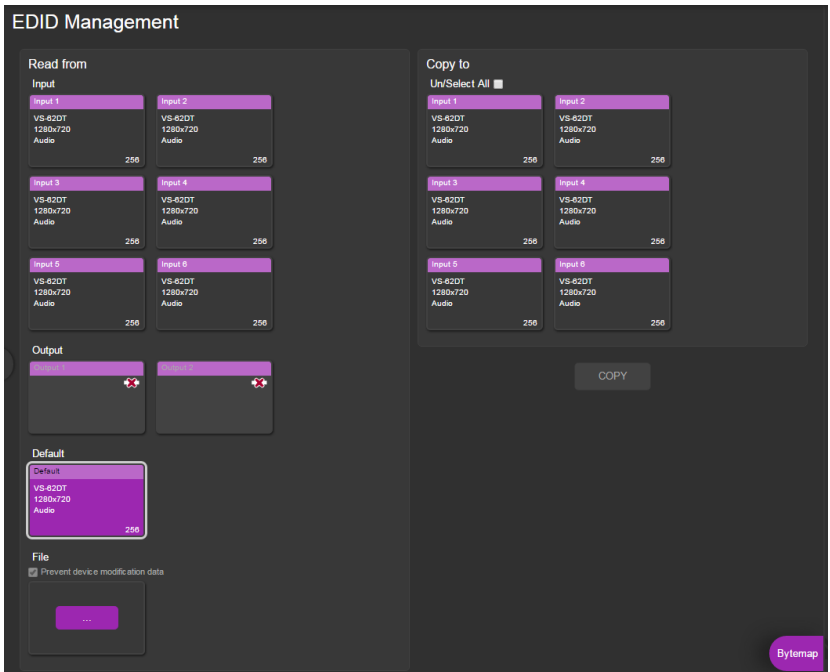



Figure 15: EDID Management Page



When the status of an EDID changes on the device (caused by outputs being exchanged), the display is not updated automatically. In the browser, click **Refresh** to update the display.

Item		Description
Read from Section	Input 1 thru 6 buttons	Click to read the EDID from each HDMI input, 1 through 6
	Output button 	Click to read the EDID from output 1 or 2 Icon indicates output is not connected
	DEFAULT EDID button	Click to read the default EDID
	Prevent Device Modification Data Checkbox	Check to lock the EDID file and prevent any device from changing it.
	File ...	Click to open the file browser to select an EDID file on your computer
Short Summary information inside the boxes		Displays the current election of EDID source, destination, video resolution, audio availability, and EDID size in bytes
Copy to Section	Un/Select All selection box	Check to select or deselect all inputs
	Input 1 thru 6 buttons	Click to copy the EDID to any HDMI input, 1 through 6
COPY Button		Click to copy the EDID from the selected source to the selected destination
BYTEMAP Button		Click to view the hex code of the EDID

To copy EDID data from an Output or Input or Default to one or more inputs:

1. Click the source button from which to copy the EDID (Output or Input or Default).
The button changes color and the EDID summary information reflects the EDID data.
2. Click one or more destination Inputs, or select all Inputs by checking the Inputs check-box.
All selected Input buttons change color and the EDID summary information reflects the Input selection(s).
3. Click the **Copy** button.
The "EDID was copied" success message is displayed and the EDID data are copied to the selected Input(s).
4. Click **OK**.

To copy EDID data to an Input from an EDID data file:

1. Click the source **Browse** button.
The Windows Browser opens.
2. Browse to the required file.

3. Select the required file and click **Open**.
The EDID summary information reflects the selection.
4. Click one or more destination Inputs, or select all Inputs by checking the Inputs check-box.
All selected Input buttons change color and the EDID summary information reflects the Input selection(s).
5. Click the **Copy** button.
The “EDID was copied” success message is displayed and the EDID data are copied to the selected Input(s).
6. Click **OK**.

To see the EDID data file:

- Click **Bytemap** in the lower right-hand corner.
The EDID data appears in hexadecimal:

DEFAULT																			
0	1	2	3	4	5	6	7	8	9	10	11	12	13	14	15	16	17	18	
00	FF	FF	FF	FF	FF	FF	00	2D	82	00	12	00	00	00	FF	19	01		
19	20	21	22	23	24	25	26	27	28	29	30	31	32	33	34	35	36	37	
03	80	94	20	78	EA	B3	25	AC	51	30	B4	26	10	50	54	FF	FF	80	
38	39	40	41	42	43	44	45	46	47	48	49	50	51	52	53	54	55	56	
81	8F	81	99	A9	40	61	59	45	59	31	59	71	4A	81	40	01	1D	00	
57	58	59	60	61	62	63	64	65	66	67	68	69	70	71	72	73	74	75	
72	51	D0	1E	20	6E	28	55	00	07	44	21	00	00	1E	00	00	00	FD	
76	77	78	79	80	81	82	83	84	85	86	87	88	89	90	91	92	93	94	
00	38	4C	1E	53	11	00	0A	20	20	20	20	20	20	00	00	00	00	FC	00
95	96	97	98	99	100	101	102	103	104	105	106	107	108	109	110	111	112	113	
56	53	2D	36	32	44	54	20	20	20	20	20	20	00	00	00	00	00	00	
114	115	116	117	118	119	120	121	122	123	124	125	126	127	128	129	130	131	132	
00	00	00	00	00	00	00	00	00	00	00	00	01	7D	02	03	1B	F1	23	
133	134	135	136	137	138	139	140	141	142	143	144	145	146	147	148	149	150	151	
09	07	07	48	10	05	84	03	02	07	16	01	65	03	0C	00	10	00	83	
152	153	154	155	156	157	158	159	160	161	162	163	164	165	166	167	168	169	170	
01	00	00	02	3A	80	18	71	38	2D	40	58	2C	25	00	07	44	21	00	
171	172	173	174	175	176	177	178	179	180	181	182	183	184	185	186	187	188	189	
00	1E	01	1D	80	18	71	1C	16	20	58	2C	25	00	07	44	21	00	00	
190	191	192	193	194	195	196	197	198	199	200	201	202	203	204	205	206	207	208	
9E	01	1D	00	72	51	D0	1E	20	6E	28	55	00	07	44	21	00	00	1E	
209	210	211	212	213	214	215	216	217	218	219	220	221	222	223	224	225	226	227	
8C	0A	D0	8A	2D	E0	2D	10	10	3E	96	00	07	44	21	00	00	18	00	
228	229	230	231	232	233	234	235	236	237	238	239	240	241	242	243	244	245	246	
00	00	00	00	00	00	00	00	00	00	00	00	00	00	00	00	00	00	00	
247	248	249	250	251	252	253	254	255											
00	00	00	00	00	00	00	00	00	47										

Figure 16: EDID Bytemap

9.5 Setting Authentication

The Authentication page enables activating device security and defining logon authentication details. When device security is enabled, Web page access requires authentication. The default user ID is **Admin** and the password is **Admin**.

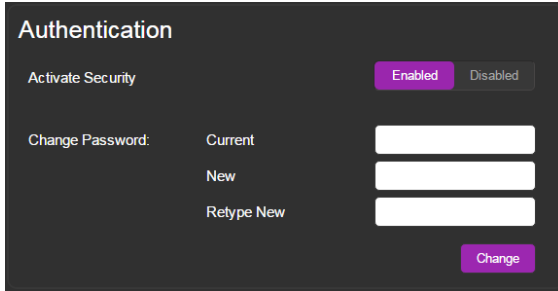

The screenshot shows the 'Authentication' page with a dark background. At the top, there is a section for 'Activate Security' with two buttons: 'Enabled' (highlighted in purple) and 'Disabled'. Below this is a 'Change Password' section with three input fields: 'Current', 'New', and 'Retype New'. A purple 'Change' button is located at the bottom right of the form.

Figure 17: Authentication Page

Item		Description
<i>Activate Security</i> Button		Click to enable/disable security settings. When enabled, the valid username and password must be provided to allow Web page access
<i>Change Password</i>	<i>Current</i> Password box	Enter the current password
	<i>New</i> Password box	Enter the new password, (up to 15 printable ASCII characters)
	<i>Retype New</i> Password box	Retype the new password
<i>CHANGE</i> button		Click CHANGE to save the new authentication details

9.6 Setting Device Configurations

The Device Settings page enables you to identify your **VS-62DT**:

- Set the unit name and view the model type, firmware version, serial number and MAC address.
- Edit IP settings, (for example, enable DHCP, set IP, mask and gateway addresses and set UDP or TCP ports).
- Save and load configurations.
- Reset the device to factory default settings.

Device Settings

Unit name

Model **VS-62DT**

Firmware version **1.5.37030**

Serial number

Ethernet Settings

DHCP

IP address

Mask address

Gateway address

Mac address **00-1d-56-4c-81-ea**

UDP port

All settings

Figure 18: Device Settings Page

Item	Description
<i>Unit Name</i>	Enter a descriptive, easy to identify name for the VS-62DT
<i>Model</i>	Displays the model of the device
<i>Firmware version</i>	Displays the firmware version of the device
<i>Serial number</i>	Displays the serial number of the device
Ethernet Settings	
DHCP ON/OFF Buttons	Click ON to turn DHCP on; click OFF to turn DHCP off and use static IP addressing
<i>IP address</i>	The IP address of the device. To set a new IP address, enter the new valid IP address and click Set
<i>Mask address</i>	The network mask of the device. To set a new mask, enter the new valid mask and click Set
<i>Gateway address</i>	The network gateway for the device. To set a new network gateway, enter the new valid gateway and click Set
<i>Set Button</i>	Click to set the Ethernet settings
<i>MAC address</i>	Read-only field showing the MAC address
<i>UDP port</i>	The UDP port number of the device. To set a new UDP port number, enter the new valid port number or use the spin controls and click Set

Item	Description
All settings	
<i>Load & Save</i> buttons	Click Load to retrieve a previously saved configuration, click Save to save the present configuration (see Section 9.3.1)
<i>Factory reset</i> button	Click to reset the device to factory default parameters. After the success message is displayed, turn the device off and on (see Section 9.3.2)

9.6.1 Loading and Saving Configurations

The **VS-62DT** enables loading and saving device setting configurations. This is especially useful when setting up multiple **VS-62DT** devices.

To load a configuration:

1. Click **Load**.
The File Upload browser window appears.
2. Browse to the required file and click **Open**.
The configuration is retrieved and the success message is displayed.

To save the current configuration:

1. Click **Save**.
The Save Configuration success message is displayed.
2. Click **Download** to either open the file or save it to the required location.
Or,
Click **OK** to complete the procedure.

9.7 Upgrading the Firmware

As problems are fixed or features are added, new firmware versions are released for downloading on the Kramer website.

To upgrade the firmware:

1. Open the Firmware Upgrade page.

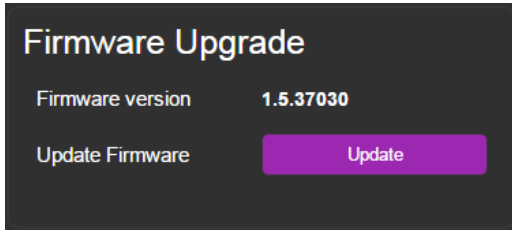

Figure 19: Firmware Upgrade

2. Click **Update**.

The Windows Browser opens.

3. Browse to the required file and click **Open**.

The firmware file name is displayed in the Firmware Upgrade page.

4. Click **Start Upgrade**.

The firmware file is loaded and a progress bar is displayed.



Do not interrupt the process or the **VS-62DT** may be damaged.

5. When the process is complete reboot the device.

The firmware is upgraded.



You can upgrade firmware for multiple **VS-62DT** devices installed in the organization via the Kramer Network.

9.8 About Kramer

The **VS-62DT** About Us page displays the web version and Kramer Electronics Ltd company contact details.



Figure 20: About Kramer

10 Wiring the Twisted Pair RJ-45 Connectors

Connect/solder the cable shield to the RJ-45 connector shield.



Do not use a crossed TP cable with this product.

Using a TP cable that is incorrectly wired may cause permanent damage to the device

Do not use unshielded TP cables with this product

[Figure 21](#) defines the TP pinout using a straight pin-to-pin cable with RJ-45 connectors.

EIA /TIA 568B	
PIN	Wire Color
1	Orange / White
2	Orange
3	Green / White
4	Blue
5	Blue / White
6	Green
7	Brown / White
8	Brown
Pairing	
Pair 1	4 and 5
Pair 2	1 and 2
Pair 3	3 and 6
Pair 4	7 and 8

Figure 21: TP Pinout Wiring

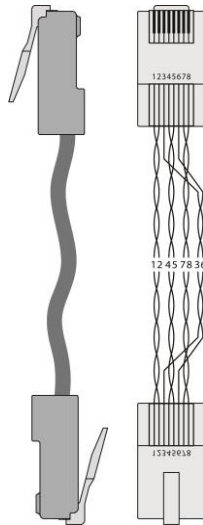

11 Technical Specifications

INPUTS:	6 HDMI connectors
OUTPUTS:	1 HDMI connector, 1 HDBT on an RJ-45 connector
PORTS:	1 Ethernet on an RJ-45 connector 12 remote selection contact-closure switches on 13 terminal block pins 1 serial port on a 3-pin terminal block 1 program port on a mini USB
ANALOG AUDIO:	2 balanced stereo audio on 5-pin terminal blocks
BANDWIDTH:	Up to 8.91Gbps data rate (2.97Gbps per graphic channel)
COMPLIANCE WITH HDMI STANDARD:	HDMI 1.4 and HDCP 1.4
RESOLUTION:	Up to 4K@60Hz UHD (4:2:0)
RANGE:	Up to 40m (130ft) at 4K @60Hz (4:2:0) Up to 70m (230ft) at full HD (1080p @60Hz 36bpp)
SUPPORTED BAUD RATES:	9600, 115200bps
POWER CONSUMPTION:	48V DC 360mA
CONTROLS:	Front panel buttons, infrared remote control transmitter, RS-232, Ethernet, remote input selection switches and LEDs, built-in Web browser
OPERATING TEMPERATURE:	0° to +40°C (32° to 104°F)
LED INDICATORS:	IR active - red, ON - green
STORAGE TEMPERATURE:	-40° to +70°C (-40° to 158°F)
HUMIDITY:	10% to 90%, RHL non-condensing
POWER CONSUMPTION:	48V DC, 360mA
DIMENSIONS:	21.5cm x16.3cm x 4.4cm (8.4" x 6.4" x 7.2") W, D, H
WEIGHT:	1.03kg (2.3lbs) approx.
SHIPPING DIMENSIONS:	35.1cm x 21.2cm x 7.2cm (13.8" x 8.4" x 2.8") W, D, H
SHIPPING WEIGHT:	1.67kg (3.7lbs) approx.
INCLUDED ACCESSORIES:	Power supply, IR remote control
OPTIONS:	RK-1 19" rack adapter
Specifications are subject to change without notice at www.kramerav.com	

12 Default Communication Parameters

RS-232	
Protocol 3000	
Baud Rate:	115,200 (9600)
Data Bits:	8
Stop Bits:	1
Parity:	None
Command Format:	ASCII
TCP/IP Parameters	
IP Address:	192.168.1.39
Subnet Mask:	255.255.255.0
Default Gateway:	192.168.1.254
UDP Port #:	50000
TCP Port #:	5000

13 Default EDID

Monitor

Model name..... VS-62DT
Manufacturer..... KMR
Plug and Play ID..... KMR0200
Serial number..... 1
Manufacture date..... 2010, ISO week 24
Filter driver..... None

EDID revision..... 1.3
Input signal type..... Digital (DVI)
Color bit depth..... Undefined
Display type..... RGB color
Screen size..... 700 x 390 mm (31.5 in)
Power management..... Not supported
Extension blocs..... 1 (CEA-EXT)

DDC/CI..... n/a

Color characteristics

Default color space..... Non-sRGB
Display gamma..... 2.20
Red chromaticity..... Rx 0.640 - Ry 0.341
Green chromaticity..... Gx 0.286 - Gy 0.610
Blue chromaticity..... Bx 0.146 - By 0.069
White point (default).... Wx 0.284 - Wy 0.293
Additional descriptors... None

Timing characteristics

Horizontal scan range.... 31-94kHz
Vertical scan range..... 50-85Hz
Video bandwidth..... 170MHz
CVT standard..... Not supported
GTF standard..... Not supported
Additional descriptors... None
Preferred timing..... Yes
Native/preferred timing.. 1280x720p at 60Hz
Modeline..... "1280x720" 74.250 1280 1430 1650 720 725 730 746 +hsync -vsync
Detailed timing #1..... 1920x1080p at 60Hz (16:9)
Modeline..... "1920x1080" 148.500 1920 2008 2052 2200 1080 1084 1089 1125 +hsync +vsync

Standard timings supported

720 x 400p at 70Hz - IBM VGA
720 x 400p at 88Hz - IBM XGA2
640 x 480p at 60Hz - IBM VGA
640 x 480p at 67Hz - Apple Mac II
640 x 480p at 72Hz - VESA
640 x 480p at 75Hz - VESA
800 x 600p at 56Hz - VESA
800 x 600p at 60Hz - VESA
800 x 600p at 72Hz - VESA
800 x 600p at 75Hz - VESA
832 x 624p at 75Hz - Apple Mac II
1024 x 768i at 87Hz - IBM
1024 x 768p at 60Hz - VESA
1024 x 768p at 70Hz - VESA
1024 x 768p at 75Hz - VESA
1280 x 1024p at 75Hz - VESA
1152 x 870p at 75Hz - Apple Mac II
1280 x 720p at 60Hz - VESA STD
1280 x 800p at 60Hz - VESA STD
1440 x 900p at 60Hz - VESA STD
1280 x 960p at 60Hz - VESA STD
1280 x 1024p at 60Hz - VESA STD
1400 x 1050p at 60Hz - VESA STD
1680 x 1050p at 60Hz - VESA STD
1600 x 1200p at 60Hz - VESA STD

EIA/CEA-861 Information

Revision number..... 3
 IT underscan..... Not supported
 Basic audio..... Supported
 YCbCr 4:4:4..... Supported
 YCbCr 4:2:2..... Supported
 Native formats..... 1
 Detailed timing #1..... 720x480p at 60Hz (4:3)
 Modeline..... "720x480" 27.000 720 736 798 858 480 489 495 525 -hsync -vsync
 Detailed timing #2..... 1920x1080i at 60Hz (16:9)
 Modeline..... "1920x1080" 74.250 1920 2008 2052 2200 1080 1084 1094 1124 interlace +hsync +vsync
 Detailed timing #3..... 1920x1080i at 50Hz (16:9)
 Modeline..... "1920x1080" 74.250 1920 2448 2492 2640 1080 1084 1094 1124 interlace +hsync +vsync
 Detailed timing #4..... 1280x720p at 60Hz (16:9)
 Modeline..... "1280x720" 74.250 1280 1390 1430 1650 720 725 730 750 +hsync +vsync
 Detailed timing #5..... 1280x720p at 50Hz (16:9)
 Modeline..... "1280x720" 74.250 1280 1720 1760 1980 720 725 730 750 +hsync +vsync

CE video identifiers (VICs) - timing/formats supported

720 x 576p at 50Hz - EDTV (4:3, 16:15)
 1280 x 720p at 50Hz - HDTV (16:9, 1:1)
 1920 x 1080i at 60Hz - HDTV (16:9, 1:1)
 1920 x 1080i at 50Hz - HDTV (16:9, 1:1)
 1280 x 720p at 60Hz - HDTV (16:9, 1:1) [Native]
 1920 x 1080p at 60Hz - HDTV (16:9, 1:1)
 1920 x 1080p at 50Hz - HDTV (16:9, 1:1)
 NB: NTSC refresh rate = (Hz*1000)/1001

CE audio data (formats supported)

LPCM 3-channel, 24-bits at 44/48 kHz

CE speaker allocation data

Channel configuration.... 3.0
 Front left/right..... Yes
 Front LFE..... No
 Front center..... Yes
 Rear left/right..... No
 Rear center..... No
 Front left/right center.. No
 Rear left/right center... No
 Rear LFE..... No

CE vendor specific data (VSDB)

IEEE registration number. 0x000C03
 CEC physical address.... 1.0.0.0
 Maximum TMDS clock..... 165MHz

Raw data

00,FF,FF,FF,FF,FF,FF,00,2E,4D,00,02,01,00,00,00,18,14,01,03,81,46,27,78,0A,D5,7C,A3,57,49,9C,25,
 11,48,4B,FF,FF,FF,80,81,C0,81,00,95,00,81,40,81,80,90,40,B3,00,A9,40,01,1D,00,72,51,D0,1A,20,6E,28,
 55,00,7E,88,42,00,00,1A,02,3A,80,18,71,38,2D,40,58,2C,45,00,C4,8E,21,00,00,1E,00,00,00,FC,00,56,
 53,2D,34,32,48,4E,0A,20,20,00,00,00,00,00,FD,00,32,55,1F,5E,11,00,0A,20,20,20,20,20,01,7B,
 02,03,1A,71,47,11,13,05,14,84,10,1F,23,0A,06,04,83,05,00,00,65,03,0C,00,10,00,8C,0A,D0,8A,20,E0,
 2D,10,10,3E,96,00,58,C2,21,00,00,18,01,1D,80,18,71,1C,16,20,58,2C,25,00,C4,8E,21,00,00,9E,01,1D,
 80,D0,72,1C,16,20,10,2C,25,80,C4,8E,21,00,00,9E,01,1D,00,72,51,D0,1E,20,6E,28,55,00,C4,8E,21,00,
 00,1E,01,1D,00,BC,52,D0,1E,20,B8,28,55,40,C4,8E,21,00,00,1E,00,00,00,00,00,00,00,00,00,00,90

14 Protocol 3000

The **VS-62DT** can be operated using the Kramer Protocol 3000 serial commands. The command framing varies according to how you interface with the **VS-62DT**. For example, a basic video input switching command that routes a layer 1 video signal to HDMI out 1 from HDMI input 2 (`ROUTE 1,1,2`), is entered as follows:

- Terminal communication software, such as Hercules:

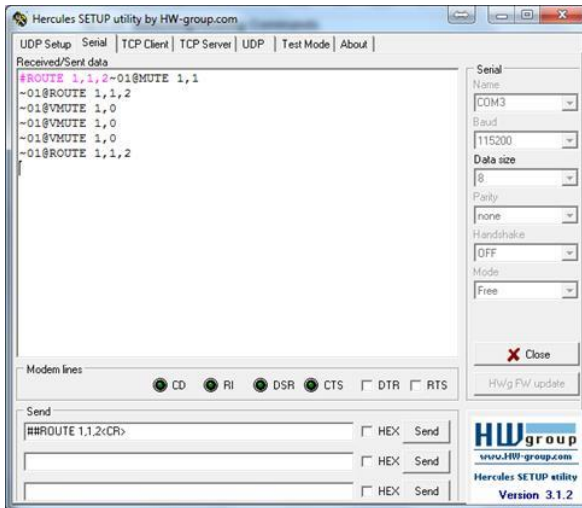

The framing of the command varies according to the terminal communication software.

- K-Touch Builder (Kramer software):

'Device Code (17)' PROPERTIES	
name	Device Code (17)
data	#ROUTE 1,1,2x0D

- K-Config (Kramer configuration software):

```
"#ROUTE 1,1,2",0x0D
```

Set

Clear



All the examples provided in this section are based on using the K-Config software.

You can enter commands directly using terminal communication software (e.g., Hercules) by connecting a PC to the serial or Ethernet port on the **VS-62DT**. To enter `CR` press the Enter key (`LF` is also sent but is ignored by the command parser).

Commands sent from various non-Kramer controllers (e.g., Crestron) may require special coding for some characters (such as, `/x##`). For more information, refer to your controller's documentation.

For more information about:

- Using Protocol 3000 commands, see [Section 14.1](#)
- General syntax used for Protocol 3000 commands, see [Section 14.2](#)
- Protocol 3000 commands available for the **VS-62DT**, see [Section 14](#)

14.1 Understanding Protocol 3000

Protocol 3000 commands are structured according to the following:

- **Command** – A sequence of ASCII letters (`A-Z`, `a-z` and `-`). A command and its parameters must be separated by at least one space.
- **Parameters** – A sequence of alphanumeric ASCII characters (`0-9`, `A-Z`, `a-z` and some special characters for specific commands). Parameters are separated by commas.
- **Message string** – Every command entered as part of a message string begins with a message starting character and ends with a message closing character.



A string can contain more than one command. Commands are separated by a pipe (`|`) character.

The maximum string length is 64 characters.

- **Message starting character:**
 - # – For host command/query
 - ~ – For device response
- **Device address** – K-NET Device ID followed by @ (optional, K-NET only)
- **Query sign** – ? follows some commands to define a query request
- **Message closing character:**
 - CR – Carriage return for host messages (ASCII 13)
 - CR LF – Carriage return for device messages (ASCII 13) and line-feed (ASCII 10)
- **Command chain separator character** – Multiple commands can be chained in the same string. Each command is delimited by a pipe character (|). When chaining commands, enter the message starting character and the message closing character only at the beginning and end of the string.



Spaces between parameters or command terms are ignored. Commands in the string do not execute until the closing character is entered. A separate response is sent for every command in the chain.

14.2 Kramer Protocol 3000 Syntax

The Kramer Protocol 3000 syntax uses the following delimiters:

- CR = Carriage return (ASCII 13 = 0x0D)
- LF = Line feed (ASCII 10 = 0x0A)
- SP = Space (ASCII 32 = 0x20)

Some commands have short name syntax in addition to long name syntax to enable faster typing. The response is always in long syntax.

The Protocol 3000 syntax is in the following format:

- Host Message Format:

Start	Address (optional)	Body	Delimiter
#	<i>Device_id@</i>	Message	CR

- Simple **Command** – Command string with only one command without addressing:

Start	Address (optional)	Body	Delimiter
#		Command SP <i>Parameter_1,Parameter_2,...</i>	CR

- **Command String** – Formal syntax with command concatenation and addressing:

Start	Address	Body	Delimiter
#	<i>Device_id@</i>	Command_1 <i>Parameter1_1,Parameter1_2,...</i> Command_2 <i>Parameter2_1,Parameter2_2,...</i> Command_3 <i>Parameter3_1,Parameter3_2,... ...</i>	CR

- Device Message Format:

Start	Address (optional)	Body	Delimiter
~	<i>Device_id@</i>	Message	CR LF

- Device Long Response – Echoing command:

Start	Address (optional)	Body	Delimiter
~	<i>Device_id@</i>	Command SP [<i>Param1 ,Param2 ...</i>] result	CR LF

15 Kramer Protocol 3000 Commands

This section lists and describes all the commands of Protocol 3000.

- System Commands - Mandatory (see [Section 15.1](#))
- System Commands (see [Section 15.2](#))
- Switching/Routing Commands (see [Section 15.3](#))
- Communication Commands (see [Section 15.4](#))
- EDID Handling Commands (see [Section 15.5](#))
- Step-in commands (see [Section 15.6](#))
- Audio Commands (see [Section 15.7](#))
- Video Commands (see [Section 15.8](#))

15.1 System Commands - Mandatory

All devices running Protocol 3000 use these commands.

Command	Description	Type	Permission
#	Protocol handshaking	System-mandatory	End User
BUILD-DATE?	Get device build date	System-mandatory	End User
FACTORY	Reset to factory default configuration	System-mandatory	End User
HELP	Get command list	System-mandatory	End User
MODEL?	Get device model	System-mandatory	End User
PROT-VER?	Get device protocol version	System-mandatory	End User
RESET	Reset device	System-mandatory	Administrator
SN?	Get device serial number	System-mandatory	End User
VERSION?	Get device firmware version	System-mandatory	End User

15.1.1

Command Name		Permission	Transparency
Set:	#	End User	Public
Get:	-	-	-
Description		Syntax	
Set:	Protocol handshaking	# <code>CR</code>	
Get:	-	-	
Response			
~ <code>nn</code> @ <code>SP</code> OK <code>CR LF</code>			
Parameters			
Response Triggers			
Notes			
Validates the Protocol 3000 connection and gets the machine number Step-in master products use this command to identify the availability of a device			
K-Config Example			
`#`, 0x0D			

15.1.2 BUILD-DATE?

Command Name		Permission	Transparency
Set:	-	-	-
Get:	BUILD-DATE?	End User	Public
Description		Syntax	
Set:	-	-	
Get:	Get device build date	#BUILD-DATE? <input type="checkbox"/>	
Response			
~ <input type="checkbox"/> <input type="checkbox"/> @BUILD-DATE <input type="checkbox"/> date <input type="checkbox"/> time <input type="checkbox"/> <input type="checkbox"/> <input type="checkbox"/>			
Parameters			
<i>date</i> - Format: YYYY/MM/DD where YYYY = Year, MM = Month, DD = Day			
<i>time</i> - Format: hh:mm:ss where hh = hours, mm = minutes, ss = seconds			
Response Triggers			
Notes			
K-Config Example			
"#BUILD-DATE?", 0x0D			

15.1.3 FACTORY

Command Name		Permission	Transparency
Set:	FACTORY	End User	Public
Get:	-	-	-
Description		Syntax	
Set:	Reset device to factory default configuration	#FACTORY <input type="checkbox"/>	
Get:	-	-	
Response			
~ <input type="checkbox"/> <input type="checkbox"/> @FACTORY <input type="checkbox"/> OK <input type="checkbox"/> <input type="checkbox"/> <input type="checkbox"/>			
Parameters			
Response Triggers			
Notes			
This command deletes all user data from the device. The deletion can take some time. Your device may require powering off and powering on for the changes to take effect.			
K-Config Example			
"#FACTORY", 0x0D			

15.1.4 HELP

Command Name		Permission	Transparency
Set:	-	-	-
Get:	HELP	End User	Public
Description		Syntax	
Set:	-	-	
Get:	Get command list or help for specific command	2 options: 1. #HELP[CR] 2. #HELP[SP]command_name[CR]	
Response			
1. Multi-line: ~[nn]@Device available protocol 3000 commands:[CR LF]command[SP]command..[CR LF] To get help for command use: HELP (COMMAND_NAME)[CR LF]			
2. Multi-line: ~[nn]@HELP[SP]command:[CR LF]description[CR LF]USAGE:usage[CR LF]			
Parameters			
Response Triggers			
Notes			
K-Config Example			
"#HELP", 0x0D			

15.1.5 MODEL?

Command Name		Permission	Transparency
Set:	-	-	-
Get:	MODEL?	End User	Public
Description		Syntax	
Set:	-	-	
Get:	Get device model	#MODEL?[CR]	
Response			
~[nn]@MODEL[SP]model_name[CR LF]			
Parameters			
model_name - string of up to 19 printable ASCII chars			
Response Triggers			
Notes			
This command identifies equipment connected to Step-in master products and notifies of identity changes to the connected equipment. The Matrix saves this data in memory to answer REMOTE-INFO requests			
K-Config Example			
"#MODEL?", 0x0D			

15.1.6 PROT-VER

Command Name		Permission	Transparency
Set:	-	-	-
Get:	PROT-VER?	End User	Public
Description		Syntax	
Set:	-	-	
Get:	Get device protocol version	#PROT-VER? <input type="checkbox"/> CR	
Response			
~ <input type="checkbox"/> [n] <input type="checkbox"/> @PROT-VER _{SP} 3000:version _{CR LF}			
Parameters			
version-XX.XX where X is a decimal digit			
Response Triggers			
Notes			
K-Config Example			
"#PROT-VER?",0x0D			

15.1.7 RESET

Command Name		Permission	Transparency
Set:	RESET	Administrator	Public
Get:	-	-	-
Description		Syntax	
Set:	Reset device	#RESET <input type="checkbox"/> CR	
Get:	-	-	
Response			
~ <input type="checkbox"/> [n] <input type="checkbox"/> @RESET _{SP} OK _{CR LF}			
Parameters			
Response Triggers			
Notes			
To avoid locking the port due to a USB bug in Windows, disconnect USB connections immediately after running this command. If the port was locked, disconnect and reconnect the cable to reopen the port.			
K-Config Example			
"#RESET",0x0D			

15.1.8 SN?

Command Name		Permission	Transparency
Set:	-	-	-
Get:	SN?	End User	Public
Description		Syntax	
Set:	-	-	
Get:	Get device serial number	#SN?	<input type="checkbox"/> CR
Response			
~ <input type="checkbox"/> nn@SN _{SP} serial_number _{CR LF}			
Parameters			
serial_number - 14 decimal digits, factory assigned			
Response Triggers			
Notes			
K-Config Example			
"#SN?", 0x0D			

15.1.9 VERSION?

Command Name		Permission	Transparency
Set:	-	-	-
Get:	VERSION?	End User	Public
Description		Syntax	
Set:	-	-	
Get:	Get firmware version number	#VERSION?	<input type="checkbox"/> CR
Response			
~ <input type="checkbox"/> nn@VERSION _{SP} firmware_version _{CR LF}			
Parameters			
firmware_version - XX.XX.XXXX where the digit groups are: major.minor.build version			
Response Triggers			
Notes			
K-Config Example			
"#VERSION?", 0x0D			

15.2 System Commands

Command	Description	Type	Permission
AV-SW-MODE	Set/get auto switch mode	System	End user
HDCP-MOD	Set/get HDCP mode	System	Administrator
HDCP-STAT?	Get HDCP signal status	System	End user
LOCK-FP	Set/get front panel lock	System	Administrator
NAME	Set/get machine (DNS) name	System	Administrator
NAME-RST	Reset machine name to factory default (DNS)	System	Administrator
PRIO	Set/get input priority	System	Administrator
SIGNAL?	Get input signal lock status	System	End User

15.2.1 AV-SW-MODE

Command Name		Permission	Transparency
Set:	AV-SW-MODE	End user	Public
Get:	AV-SW-MODE?	End user	Public
Description		Syntax	
Set:	Set input auto switch mode (per output)	#AV-SW-MODE _[sp] layer,output_id,mode _[cr]	
Get:	Get input auto switch mode (per output)	#AV-SW-MODE? _[sp] layer,output_id _[cr]	
Response			
~ _[nr] @AV-SW-MODE _[sp] layer,output_id,mode _[cr LF]			
Parameters			
layer - 1 (video)			
output_id - for video layer: 1 (HDMI Out)			
mode - 0 (manual), 1 (priority switch), 2 (last connected switch)			
Response Triggers			
Notes			
K-Config Example			
Get the input audio switch mode for HDMI Out: "#AV-SW-MODE? 1,1",0x0D			

15.2.2 DISPLAY?

Command Name		Permission	Transparency
Set:	-	-	-
Get	DISPLAY?	End User	Public
Description		Syntax	
Set:	-	-	
Get:	Get output HPD status	#DISPLAY? <input type="checkbox"/> <i>out_id</i> <input type="checkbox"/>	
Response			
~ <input type="checkbox"/> @DISPLAY <input type="checkbox"/> <i>out_id</i> , <i>status</i> <input type="checkbox"/>			
Parameters			
<i>out_id</i> - 1 (HDMI Out)			
<i>status</i> - HPD status according to signal validation : 0 (Off), 1 (On), 2 (On and all parameters are stable and valid)			
Response Triggers			
A response is sent to the comm port from which the Get was received, after command execution and:			
After every change in output HPD status from On to Off (0)			
After every change in output HPD status from Off to On (1)			
After every change in output HPD status form Off to On and all parameters (new EDID, etc.) are stable and valid (2)			
Notes			
K-Config Example			
Get the output HPD status of HDMI Out: "#DISPLAY? 1",0x0D			

15.2.3 HDCP-MOD

Command Name		Permission	Transparency
Set:	HDCP-MOD	Administrator	Public
Get:	HDCP-MOD?	End User	Public
Description		Syntax	
Set:	Set HDCP mode	#HDCP-MOD <input type="text"/> <i>inp_id</i> , <input type="text"/> <i>mode</i> <input type="text"/>	
Get:	Get HDCP mode	#HDCP-MOD? <input type="text"/>	
Response			
Set / Get: ~ <input type="text"/> @HDCP-MOD <input type="text"/> <i>mode</i> <input type="text"/> <input type="text"/>			
Parameters			
<i>inp_id</i> - 1 (Input 1)... 6 (Input 6) <i>mode</i> - 1 (HDCP on), 0 (HDCP off)			
Response Triggers			
Response is sent to the comm port from which the Set (before execution) / Get command was received Response is sent to all comm ports after execution if HDCP-MOD was set by any other external control device (button press, device menu and similar) or HDCP mode changed			
Notes			
Set HDCP working mode on the device input: HDCP supported - HDCP_ON [default] HDCP not supported - HDCP OFF HDCP support changes following detected sink - MIRROR OUTPUT			
K-Config Example			
Disable HDCP mode on HDMI Input 2: `#HDCP-MOD 2,0",0x0D`			

15.2.4 HDCP-STAT?

Command Name		Permission	Transparency
Set:	-	-	-
Get:	HDCP-STAT?	End User	Public
Description		Syntax	
Set:	None	-	
Get:	Get HDCP signal status	#HDCP-STAT? <input type="checkbox"/> <i>stage,stage_id</i> <input type="checkbox"/>	
Response			
Set / Get: ~ <input type="checkbox"/> @HDCP-STAT <input type="checkbox"/> <i>stage,stage_id,status</i> <input type="checkbox"/> <input type="checkbox"/>			
Parameters			
<i>stage</i> - 0 (input), 1 (output), 2 (reserved), 3 (reserved)			
<i>stage_id</i> - Inputs: 1 (Input 1)... 6 (Input 6), Outputs 1 (HDBT), 2 (HDMI)			
<i>status</i> - signal encryption status - 0 (HDCP off), 1 (HDCP on)			
Response Triggers			
Response is sent to the comm port from which the Set (before execution) / Get command was received			
Response is sent to all comm ports after execution if HDCP-STAT was set by any other external control device (button press, device menu and similar) or HDCP mode changed			
Notes			
On output - sink status			
On input - signal status			
K-Config Example			
Get the HDCP input signal status of the source device connected to HDMI In 1: "#HDCP-STAT? 0,1",0x0D			

15.2.5 LOCK-FP

Command Name		Permission	Transparency
Set:	LOCK-FP	End User	Public
Get:	LOCK-FP?	End User	Public
Description		Syntax	
Set:	Lock the port	#LOCK-FP _{SP} <i>PortNumber</i> , <i>Lock/Unlock</i> _{CR}	
Get:	Get the port lock state	#LOCK-FP? _{SP} <i>PortNumber</i> _{CR}	
Response			
~ _{nn} @PORT-TYPE _{SP} <i>PortNumber</i> , <i>Lock/Unlock</i> _{CR LF}			
Parameters			
<i>PortNumber</i> - 1-2 (port number)			
<i>Lock/Unlock</i> - 0 (unlock), 1 (lock)			
Response Triggers			
Notes			
K-Config Example			
Lock the front panel: `#LOCK-FP 1",0x0D`			

15.2.6 NAME

Command Name		Permission	Transparency
Set:	NAME	Administrator	Public
Get:	NAME?	End User	Public
Description		Syntax	
Set:	Set machine (DNS) name	#NAME SP machine_name CR	
Get:	Get machine (DNS) name	#NAME? CR	
Response			
Set:	~nn@NAME SP machine_name CR LF		
Get:	~nn@NAME? SP machine_name CR LF		
Parameters			
<i>machine_name</i> - string of up to 15 alpha-numeric chars (can include hyphen, not at the beginning or end)			
Response Triggers			
Notes			
The machine name is not the same as the model name. The machine name is used to identify a specific machine or a network in use (with DNS feature on)			
K-Config Example			

15.2.7 NAME-RST

Command Name		Permission	Transparency
Set:	NAME-RST	Administrator	Public
Get:	-	-	-
Description		Syntax	
Set:	Reset machine (DNS) name to factory default	#NAME-RST CR	
Get:	-	-	
Response			
~nn@NAME-RST SP OK CR LF			
Parameters			
Response Triggers			
Notes			
Factory default of machine (DNS) name is "KRAMER_" + 4 last digits of device serial number			
K-Config Example			
Set the DNS name of the device to "room-442": "#NAME room-442", 0x0D			

15.2.8 PRIO

Command Name		Permission	Transparency
Set:	-	-	-
Get	PRIO?	Administrator	Public
Description		Syntax	
Set:	-	-	
Get:	Get input priority	#PRIO? <code>[SP]</code> <code>inp_id</code> <code>[CR]</code>	
Response			
~ <code>[n]</code> @PRIO <code>[SP]</code> <code>inp_id,prio</code> <code>[CR LF]</code>			
Parameters			
<i>inp_id</i> - window number setting new source 1 (Input 1)...6 (Input 6) <i>prio</i> - assigned priority 1 (max. priority), 6 (min. priority)			
Response Triggers			
After execution, response is sent to the comm port from which the Set/Get was received After execution, response is sent to all comm ports if PRIO was set by any other external control device (button press, device menu and similar)			
Notes			
The PRIO max value may vary for different devices			
K-Config Example			
Get the input priority Input 3: "#PRIORITY? 3",0x0D			

15.2.9 SIGNAL?

Command Name		Permission	Transparency
Set:	-	-	-
Get	SIGNAL?	End User	Public
Description		Syntax	
Set:	-	-	
Get:	Get input signal lock status	#SIGNAL? <code>[SP]</code> <code>inp_id</code> <code>[CR]</code>	
Response			
~ <code>[n]</code> @SIGNAL <code>[SP]</code> <code>inp_id,status</code> <code>[CR LF]</code>			
Parameters			
<i>inp_id</i> - 1 (Input 1)... 6 (Input 6) <i>status</i> - lock status according to signal validation - 0 (signal off), 1 (signal on)			
Response Triggers			
After execution, a response is sent to the comm port from which the Get was received Response is sent after every change in input signal status ON to OFF, or OFF to ON			
Notes			
K-Config Example			
Get the input signal lock status of HDMI In 2: "#SIGNAL? 2",0x0D			

15.3 Switching/Routing Commands

Note: Use the **ROUTE** command in preference to legacy AUD, VID, and AV commands (see below).

Command	Description	Type	Permission
MTX-MODE	Set/get auto-switch mode	Switching	End User
ROUTE	Set/get layer routing	Routing	End User
VID	Set/get video switch state	Switching	End User

15.3.1 MTX-MODE

Command Name		Permission	Transparency
Set:	MTX-MODE	End User	Public
Get:	MTX-MODE?	End User	Public
Description		Syntax	
Set:	Set auto-switch mode	#MTX-MODE _{sp} output_id,mode _{cr}	
Get :	Get auto-switch mode	#MTX-MODE? _{sp} output_id _{cr}	
Response			
~nn@MTX-MODE _{sp} output_id,mode _{cr}			
Parameters			
output_id - 1 (HDBT), 2 (HDMI) mode - 0 (manual), 1 (auto priority), 2 (auto last connected)			
Response Triggers			
After execution, a response is sent to the comm port from which the Set/Get was received After execution, a response is sent to all comm ports if MTX-MODE was set by any other external control device (button press, WEB, device menu and similar)			
Notes			
Not recommended for new devices			
K-Config Example			
Set the auto switch mode of HDMI Out to last connected input: "#MTX-MODE 1,2",0x0D			

15.3.2 ROUTE

Command Name		Permission	Transparency
Set:	ROUTE	End User	Public
Get:	ROUTE?	End User	Public
Description		Syntax	
Set:	Set layer routing	#ROUTE <code>[SP]</code> <i>layer,dest,src</i> <code>[CR]</code>	
Get:	Get layer routing	#ROUTE? <code>[SP]</code> <i>layer,dest</i> <code>[CR]</code>	
Response			
~ <code>[nr]</code> @ROUTE <code>[SP]</code> <i>layer,dest,src</i> <code>[CR LF]</code>			
Parameters			
<i>layer</i> - 1 (video)			
<i>dest</i> - * - ALL			
x - disconnect, otherwise destination id			
<i>src</i> - source id: 1 (Input 1)...6 (Input 6)			
Response Triggers			
Notes			
This command replaces all other routing commands			
K-Config Example			
Set the remote input switching of video to HDMI Out from HDMI In 2: `#ROUTE 1,1,2",0x0D`			

15.3.3 VID

Command Name		Permission	Transparency
Set:	VID	End User	Public
Get:	VID?	End User	Public
Description		Syntax	
Set:	Set video switch state	#VID _{SP} <i>in</i> > <i>out</i> _{CR}	
Get:	Get video switch state	#VID? _{SP} <i>out</i> _{CR}	
Response			
Set:	~ _{nn} @VID _{SP} <i>in</i> > <i>out</i> _{CR LF}		
Get:	~ _{nn} @VID _{SP} <i>in</i> > <i>out</i> _{CR LF}		
Parameters			
<i>in</i> - 1 (Input 1)...6 (Input 6) or 0 (disconnect output)			
> - connection character between in and out parameters			
<i>out</i> - 1 (HDBT), 2 (HDMI), * (for all outputs)			
Response Triggers			
Notes			
The GET command identifies input switching on Step-in clients			
The SET command is for remote input switching on Step-in clients (essentially via by the Web)			
This is a legacy command. New Step-in modules support the ROUTE command			
K-Config Example			
Set the video switch state of INPUT 1 to HDBaseT: "#VID 1>1",0x0D			

15.4 Communication Commands

These commands are used by network devices running Protocol 3000.

Command	Description	Type	Permission
NET-DHCP	Set/get DHCP mode	Communication	Administrator
NET-GATE	Set/get gateway IP	Communication	Administrator
NET-IP	Set/get IP address	Communication	Administrator
NET-MAC?	Get MAC address	Communication	End User
NET-MASK	Set/get subnet mask	Communication	Administrator

15.4.1 ETH PORT

Command Name		Permission	Transparency
Set:	ETH-PORT	Administrator	Public
Get:	ETH-PORT?	End User	Public
Description		Syntax	
Set:	Set Ethernet port protocol	#ETH-PORT _{SP} <i>portType</i> ,ETHPort _{CR}	
Get:	Get Ethernet port protocol	#ETH-PORT? _{SP} <i>portType</i> _{CR}	
Response			
~nn@ETH-PORT _{SP} <i>portType</i> ,ETHPort _{CR LF}			
Parameters			
<i>portType</i> - TCP/UDP			
<i>ETHPort</i> - TCP/UDP port number			
Response Triggers			
Notes			
K-Config Example			
Set the Ethernet port protocol for TCP to port 12457: "#ETH-PORT TCP,12457",0x0D			

15.4.2 NET-DHCP

Command Name		Permission	Transparency
Set:	NET-DHCP	Administrator	Public
Get:	NET-DHCP?	End User	Public
Description		Syntax	
Set:	Set DHCP mode	#NET-DHCP <input type="checkbox"/> mode <input type="checkbox"/>	
Get:	Get DHCP mode	#NET-DHCP? <input type="checkbox"/>	
Response			
~ <input type="checkbox"/> @NET-DHCP <input type="checkbox"/> mode <input type="checkbox"/> LF			
Parameters			
<i>mode</i> - 0 (Do not use DHCP. Use the IP set by the factory or using the IP set command) 1 (Try to use DHCP. If unavailable, use IP as above)			
Response Triggers			
Notes			
Connecting Ethernet to devices with DHCP may take more time in some networks To connect with a randomly assigned IP by DHCP, specify the device DNS name (if available) using the command "NAME". You can also get an assigned IP by direct connection to USB or RS-232 protocol port if available For proper settings consult your network administrator			
K-Config Example			
Enable DHCP mode, if available: "#NET-DHCP 1", 0x0D			

15.4.3 NET-GATE

Command Name		Permission	Transparency
Set:	NET-GATE	Administrator	Public
Get:	NET-GATE?	End User	Public
Description		Syntax	
Set:	Set gateway IP	#NET-GATE <input type="text" value="ip_address"/> <input type="text"/>	
Get:	Get gateway IP	#NET-GATE? <input type="text"/>	
Response			
~ <input type="text" value="nn"/> @NET-GATE <input type="text" value="ip_address"/> <input type="text"/>			
Parameters			
<i>ip_address</i> - format: xxx.xxx.xxx.xxx			
Response Triggers			
Notes			
A network gateway connects the device via another network and maybe over the Internet. Be careful of security problems. For proper settings consult your network administrator			
K-Config Example			
Set the gateway IP address to 192.168.0.1: "#NET-GATE 192.168.000.001",0x0D			

15.4.4 NET-IP

Command Name		Permission	Transparency
Set:	NET-IP	Administrator	Public
Get:	NET-IP?	End User	Public
Description		Syntax	
Set:	Set IP address	#NET-IP _{SP} <i>ip_address</i> _{CR}	
Get:	Get IP address	#NET-IP? _{CR}	
Response			
~ _{nn} @NET-IP _{SP} <i>ip_address</i> _{CR LF}			
Parameters			
<i>ip_address</i> - format: xxx.xxx.xxx.xxx			
Response Triggers			
Notes			
For proper settings consult your network administrator			
K-Config Example			
Set the IP address to 192.168.1.39: "#NET-IP 192.168.001.039",0x0D			

15.4.5 NET-MAC

Command Name		Permission	Transparency
Set:	-	-	-
Get:	NET-MAC?	End User	Public
Description		Syntax	
Set:	-	-	
Get:	Get MAC address	#NET-MAC? _{CR}	
Response			
~ _{nn} @NET-MAC _{SP} <i>mac_address</i> _{CR LF}			
Parameters			
<i>mac_address</i> - Unique MAC address. Format: XX-XX-XX-XX-XX-XX where X is hex digit			
Response Triggers			
Notes			
K-Config Example			
"#NET-MAC?",0x0D			

15.4.6 NET-MASK

Command Name		Permission	Transparency
Set:	NET-MASK	Administrator	Public
Get:	NET-MASK?	End User	Public
Description		Syntax	
Set:	Set subnet mask	#NET-MASK	<code>net_mask</code>
Get:	Get subnet mask	#NET-MASK?	
Response			
~nn@NET-MASK net_mask LF			
Parameters			
net_mask - format: xxx.xxx.xxx.xxx			
Response Triggers			
The subnet mask limits the Ethernet connection within the local network For proper settings consult your network administrator			
Notes			
K-Config Example			
Set the subnet mask to 255.255.0.0: "#NET-MASK 255.255.000.000",0x0D			

15.5 EDID Handling Commands

Command	Description	Type	Permission
CPEDID	Copy EDID data from the output to the input EEPROM	EDID Handling	End User

15.5.1 CPEDID

Command Name		Permission	Transparency
Set:	CPEDID	End User	Public
Get:	-	-	-
Description		Syntax	
Set:	Copy EDID data from the output to the input EEPROM	#CPEDID _{SP} <i>src_type,src_id,dst_type,dest_bitmap</i> _{CR} or #CPEDID _{SP} <i>src_type,src_id,dst_type,dest_bitmap, safe_mode</i> _{CR}	
Get:	-	-	
Response			
~ _{nn} @CPEDID _{SP} <i>src_stg,src_id,dst_type,dest_bitmap</i> _{CR LF}			
~ _{nn} @CPEDID _{SP} <i>src_stg,src_id, st_type,dest_bitmap,safe_mode</i> _{CR LF}			
Parameters			
<i>src_type</i> - EDID source type (usually input): 0 (input), 1 (output), 2 (default EDID), 3 (custom EDID)			
<i>src_id</i> - number of chosen source stage (1.. max number of inputs/outputs)			
<i>dst_type</i> - EDID destination type (usually input): 0 (input), 1 (output), 2 (default EDID), 3 (custom EDID)			
<i>dest_bitmap</i> - bitmap representing destination IDs. Format: XXXX...X, where X is hex digit. The binary form of every hex digit represents corresponding destinations. Setting '1' says that EDID data has to be copied to this destination			
<i>safe_mode</i> - 0 - device accepts the EDID as is without trying to adjust 1 - device tries to adjust the EDID (default value if no parameter is sent)			
Response Triggers			
Response is sent to the comm port from which the Set was received (before execution)			
Notes			
Destination bitmap size depends on device properties (for 64 inputs it is a 64-bit word) Example: bitmap 0x0013 means inputs 1,2 and 5 are loaded with the new EDID In certain products <i>Safe_mode</i> is an optional parameter. See the HELP command for its availability			
K-Config Example			
Copy the EDID data from the HDMI Out output (EDID source) to the HDMI In 1 input: "#CPEDID 1,1,0,0x1",0x0D			
Copy the EDID data from the default EDID source to HDMI In 1 and PC In inputs: "#CPEDID 2,0,0,0x5",0x0D			

15.6 Step-In Commands

Command	Description	Type	Permission
PROG-ACTION	Set/get step-in button action list	Step-in	End User

15.6.1 PROG-ACTION

Command Name		Permission	Transparency
Set:	PROG-ACTION	End user	Public
Get:	PROG-ACTION?	End user	Public
Description		Syntax	
Set:	Set step-in button action bitmap	#PROG-ACTION ^[sp] <i>type,port_id,button_id,actions_bitmap</i> ^[cr]	
Get:	Get step-in button action bitmap	#PROG-ACTION? ^[sp] <i>port_type,port_id,button_id</i> ^[cr]	
Response			
~ ^[cr] @PROG-ACTION ^[sp] <i>port_type,port_id,button_id,actions_bitmap</i> ^[cr LF]			
Parameters			
<p><i>port_type</i> - 0 (input) <i>port_id</i> - port id: 1 (Input 1)...6 (Input 6) <i>button_id</i> - external programmable button ID <i>actions_bitmap</i> - bitmap representing actions to perform after receiving <i>button_id</i>. format: XXXX...X, where X is a hex digit. The binary form of every hex digit represents actions from the tab. Setting '1' says that the corresponding action must be executed: 0 (echo controller), 1 (step-in HDBT), 2 (step-in HDMI)</p>			
Response Triggers			
Notes			
Programs matrix action as a response for external event (programmable button pressed)			
K-Config Example			

15.7 Audio Commands

Command	Description	Type	Permission
AUD-LVL	Set/get volume level	Audio	End User
AUD-SWAP	Set/get audio output swap	Audio	End User
MUTE	Set/get audio mute	Audio	End User

15.7.1 AUD-LVL

Command Name		Permission	Transparency
Set:	AUD-LVL	End User	Public
Get:	AUD-LVL?	End User	Public
Description		Syntax	
Set:	Set volume level	#AUD-LVL _{SP} stage,channel,volume _{CR}	
Get:	Get volume level	#AUD-LVL? _{SP} stage,channel _{CR}	
Response			
~nn@AUD-LVL _{SP} stage,channel,volume _{CR LF}			
Parameters			
<i>stage</i> – 0 (input processing), 1 (output processing) <i>channel</i> – number of channel: 1 (master), 2 (secondary) <i>volume</i> – volume level: -90 to 10 (dB)			
Response Triggers			
Notes			
K-Config Example			
Set the volume of the Audio Out (1) output to 0dB: "#AUD-LVL 1,1,0",0x0D			

15.7.2 AUD-SWAP

Command Name		Permission	Transparency
Set:	AUD-SWAP	End User	Public
Get:	AUD-SWAP?	End User	Public
Description		Syntax	
Set:	Set audio output swap	#AUD-SWAP _{SP} swap_mode _{CR}	
Get:	Get audio output swap status	#AUD-SWAP? _{CR}	
Response			
~nn@AUD-SWAP _{SP} swap_mode _{CR LF}			
Parameters			
swap_mode – 0 (off), 1 (on)			
Response Triggers			
Notes			
K-Config Example			
Set audio output swapping: "#AUD-SWAP 1", 0x0D			

15.7.3 MUTE

Command Name		Permission	Transparency
Set:	MUTE	End User	Public
Get:	MUTE?	End User	Public
Description		Syntax	
Set:	Set audio mute	#MUTE <code>[SP]</code> <code>channel</code> , <code>mute_mode</code> <code>[CR]</code>	
Get:	Get audio mute	#MUTE? <code>[SP]</code> <code>channel</code> <code>[CR]</code>	
Response			
~ <code>[nn]</code> @MUTE <code>[SP]</code> <code>channel</code> , <code>mute_mode</code> <code>[CR LF]</code>			
Parameters			
<code>channel</code> - output number			
<code>mute mode</code> - 0 (off), 1 (on)			
Response Triggers			
Notes			
K-Config Example			
Mute the Audio Out output: "#MUTE 1,1",0x0D			

15.8 Video Commands

Command	Description	Type	Permission
VID-PATTERN	Set/get test pattern on output	Video	End User
VMUTE	Set/get video on output mute	Video	End User

15.8.1 VID-PATTERN

Command Name		Permission	Transparency
Set:	VID-PATTERN	End User	Public
Get:	VID-PATTERN?	End User	Public
Description		Syntax	
Set:	Set test pattern on output	#VID-PATTERN _{SP} output_id,pattern_id _{CR}	
Get :	Get test pattern on output	#VID-PATTERN? _{SP} output_id _{CR}	
Response			
~ _{nr} @VID-PATTERN _{SP} output_id,pattern_id _{CR}			
Parameters			
output_id-1 (HDBT), 2 (HDMI) pattern_id-1 (color bar), 2 (checkerboard), 3 (gradient), 4 (white), 5 (blue), 6 (green)			
Response Triggers			
After execution, response is sent to the comm port from which the set/get was received After execution, response is sent to all comm ports if VID-PATTERN was set by any other external control device (button press, WEB, device menu and similar)			
Notes			
K-Config Example			
Set HDMI Out 2 to pattern 2 (checkerboard): "#VID-PATTERN,2,2",0x0D			

15.8.2 VMUTE

Command Name		Permission	Transparency
Set:	VMUTE	End User	Public
Get:	VMUTE?	End User	Public
Description		Syntax	
Set:	Set enable/disable video on output	#VMUTE _{SP} output_id,flag _{CR}	
Get:	Get video on output status	#VMUTE? _{SP} output_id _{SP} _{CR}	
Response			
Set / Get: ~ _{nr} @VMUTE _{SP} output_id,flag _{CR LF}			
Parameters			
output_id-1 (HDBT), 2 (HDMI) flag-0 (disable video on output), 1 (enable video on output), 2 (blank video)			
Response Triggers			
Notes			

Video mute parameter 2 (blank picture) is not supported

K-Config Example

Disable the video output on HDMI Out:

```
"#VMUTE 3,0",0x0D
```

LIMITED WARRANTY

The warranty obligations of Kramer Electronics for this product are limited to the terms set forth below:

What is Covered

This limited warranty covers defects in materials and workmanship in this product.

What is Not Covered

This limited warranty does not cover any damage, deterioration or malfunction resulting from any alteration, modification, improper or unreasonable use or maintenance, misuse, abuse, accident, neglect, exposure to excess moisture, fire, improper packing and shipping (such claims must be presented to the carrier), lightning, power surges, or other acts of nature. This limited warranty does not cover any damage, deterioration or malfunction resulting from the installation or removal of this product from any installation, any unauthorized tampering with this product, any repairs attempted by anyone unauthorized by Kramer Electronics to make such repairs, or any other cause which does not relate directly to a defect in materials and/or workmanship of this product. This limited warranty does not cover cartons, equipment enclosures, cables or accessories used in conjunction with this product.

Without limiting any other exclusion herein, Kramer Electronics does not warrant that the product covered hereby, including, without limitation, the technology and/or integrated circuit(s) included in the product, will not become obsolete or that such items are or will remain compatible with any other product or technology with which the product may be used.

How Long Does this Coverage Last

Seven years as of this printing; please check our Web site for the most current and accurate warranty information.

Who is Covered

Only the original purchaser of this product is covered under this limited warranty. This limited warranty is not transferable to subsequent purchasers or owners of this product.

What Kramer Electronics will do

Kramer Electronics will, at its sole option, provide one of the following three remedies to whatever extent it shall deem necessary to satisfy a proper claim under this limited warranty:

1. Elect to repair or facilitate the repair of any defective parts within a reasonable period of time, free of any charge for the necessary parts and labor to complete the repair and restore this product to its proper operating condition. Kramer Electronics will also pay the shipping costs necessary to return this product once the repair is complete.
2. Replace this product with a direct replacement or with a similar product deemed by Kramer Electronics to perform substantially the same function as the original product.
3. Issue a refund of the original purchase price less depreciation to be determined based on the age of the product at the time remedy is sought under this limited warranty.

What Kramer Electronics will not do Under This Limited Warranty

If this product is returned to Kramer Electronics or the authorized dealer from which it was purchased or any other party authorized to repair Kramer Electronics products, this product must be insured during shipment, with the insurance and shipping charges prepaid by you. If this product is returned uninsured, you assume all risks of loss or damage during shipment. Kramer Electronics will not be responsible for any costs related to the removal or re-installation of this product from or into any installation. Kramer Electronics will not be responsible for any costs related to any setting up this product, any adjustment of user controls or any programming required for a specific installation of this product.

How to Obtain a Remedy under this Limited Warranty

To obtain a remedy under this limited warranty, you must contact either the authorized Kramer Electronics reseller from whom you purchased this product or the Kramer Electronics office nearest you. For a list of authorized Kramer Electronics resellers and/or Kramer Electronics authorized service providers, please visit our web site at www.kramerelectronics.com or contact the Kramer Electronics office nearest you.

In order to pursue any remedy under this limited warranty, you must possess an original, dated receipt as proof of purchase from an authorized Kramer Electronics reseller. If this product is returned under this limited warranty, a return authorization number, obtained from Kramer Electronics, will be required. You may also be directed to an authorized reseller or a person authorized by Kramer Electronics to repair the product.

If it is decided that this product should be returned directly to Kramer Electronics, this product should be properly packed, preferably in the original carton, for shipping. Cartons not bearing a return authorization number will be refused.

Limitation on Liability

THE MAXIMUM LIABILITY OF KRAMER ELECTRONICS UNDER THIS LIMITED WARRANTY SHALL NOT EXCEED THE ACTUAL PURCHASE PRICE PAID FOR THE PRODUCT. TO THE MAXIMUM EXTENT PERMITTED BY LAW, KRAMER ELECTRONICS IS NOT RESPONSIBLE FOR DIRECT, SPECIAL, INCIDENTAL OR CONSEQUENTIAL DAMAGES RESULTING FROM ANY BREACH OF WARRANTY OR CONDITION, OR UNDER ANY OTHER LEGAL THEORY. Some countries, districts or states do not allow the exclusion or limitation of relief, special, incidental, consequential or indirect damages, or the limitation of liability to specified amounts, so the above limitations or exclusions may not apply to you.

Exclusive Remedy

TO THE MAXIMUM EXTENT PERMITTED BY LAW, THIS LIMITED WARRANTY AND THE REMEDIES SET FORTH ABOVE ARE EXCLUSIVE AND IN LIEU OF ALL OTHER WARRANTIES, REMEDIES AND CONDITIONS, WHETHER ORAL OR WRITTEN, EXPRESS OR IMPLIED. TO THE MAXIMUM EXTENT PERMITTED BY LAW, KRAMER ELECTRONICS SPECIFICALLY DISCLAIMS ANY AND ALL IMPLIED WARRANTIES, INCLUDING, WITHOUT LIMITATION, WARRANTIES OF MERCHANTABILITY AND FITNESS FOR A PARTICULAR PURPOSE. IF KRAMER ELECTRONICS CANNOT LAWFULLY DISCLAIM OR EXCLUDE IMPLIED WARRANTIES UNDER APPLICABLE LAW, THEN ALL IMPLIED WARRANTIES COVERING THIS PRODUCT, INCLUDING WARRANTIES OF MERCHANTABILITY AND FITNESS FOR A PARTICULAR PURPOSE, SHALL APPLY TO THIS PRODUCT AS PROVIDED UNDER APPLICABLE LAW.

IF ANY PRODUCT TO WHICH THIS LIMITED WARRANTY APPLIES IS A "CONSUMER PRODUCT" UNDER THE MAGNUSON-MOSS WARRANTY ACT (15 U.S.C.A. §2301, ET SEQ.) OR OTHER APPLICABLE LAW, THE FOREGOING DISCLAIMER OF IMPLIED WARRANTIES SHALL NOT APPLY TO YOU, AND ALL IMPLIED WARRANTIES ON THIS PRODUCT, INCLUDING WARRANTIES OF MERCHANTABILITY AND FITNESS FOR THE PARTICULAR PURPOSE, SHALL APPLY AS PROVIDED UNDER APPLICABLE LAW.

Other Conditions

This limited warranty gives you specific legal rights, and you may have other rights which vary from country to country or state to state.

This limited warranty is void if (i) the label bearing the serial number of this product has been removed or defaced, (ii) the product is not distributed by Kramer Electronics or (iii) this product is not purchased from an authorized Kramer Electronics reseller. If you are unsure whether a reseller is an authorized Kramer Electronics reseller, please visit our Web site at www.kramerelectronics.com or contact a Kramer Electronics office from the list at the end of this document.

Your rights under this limited warranty are not diminished if you do not complete and return the product registration form or complete and submit the online product registration form. Kramer Electronics thanks you for purchasing a Kramer Electronics product. We hope it will give you years of satisfaction.

KRAMER



P/N: 2900-300665



Rev: 4



SAFETY WARNING

Disconnect the unit from the power supply before opening and servicing

For the latest information on our products and a list of Kramer distributors, visit our Web site to find updates to this user manual.

We welcome your questions, comments, and feedback.

www.KramerAV.com
info@KramerAV.com